



3 \_ \_ -0\_ 3030

9 \_ \_ -013030

3 \_ \_ -013530

T1

Vyplňte prosím!

-----  
Jméno

-----  
Ulice

-----  
PSC Město

-----  
Tel.

T2

Vážení zákazníci,

Jsme rádi, že jste si vybrali výrobek od společnosti Pelipal. Pokud bychom Vám i přes veškeré úsilí z naší strany nedodali některé díly, pošlete prosím tento vyplněný list na

Fax.: +49 3443/434354

E-Mail: [weissenfels.ersatzteile@pelipal.de](mailto:weissenfels.ersatzteile@pelipal.de)

Pro vyřizování stížností je naprosto nezbytné uvést číslo zboží skříňky, které lze vidět na štítku a na trhu, kde byl nábytek zakoupen. Kromě toho zadejte níže uvedené požadované množství. Bavte se s vašim novým koupelnovým nábytkem! Váš tým Pelipal











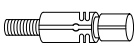

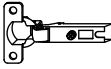

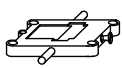
T3

Pro montáž je zapotřebí 2 osob.

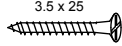
T4

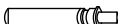
Doba montáže 3 hodiny

8 x a  DÜB-SMD-000005	kus	8 x b  EXZENTER-000015	kus	2 x c  ZPL-003X000	kus	2 x d  TBD-35-115X00	kus	1 x e  GRI-160-	kus
8 x f  TRÄ-001-000020	kus	2 x g  AUF-001-000060	kus	2 x h  AUF-001-000020	kus	2 x j  SCH-KNO-M04	kus	6 x k  3.5 x 15 SCH-SPA-035X015	kus
10 x l  hřebík-025X001	kus	2 x m  3.5 x 25 SCH-SPA-035X025	kus	2 x n  5 x 8 ADK-AL1-005X008	kus	1 x o  dveře-DÄM-000010	kus	1 x p  dveře-ADA-000010	kus

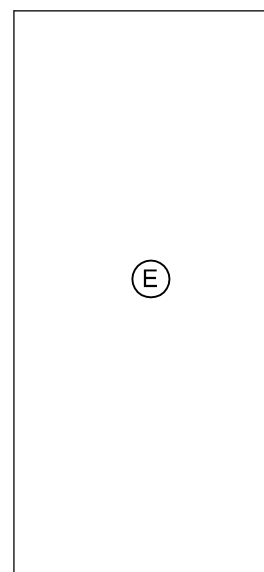
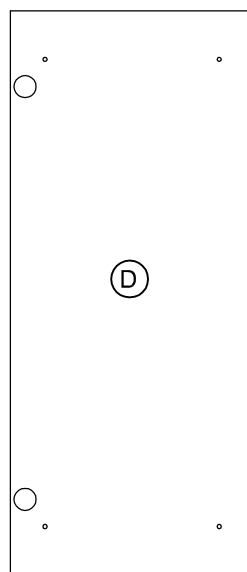
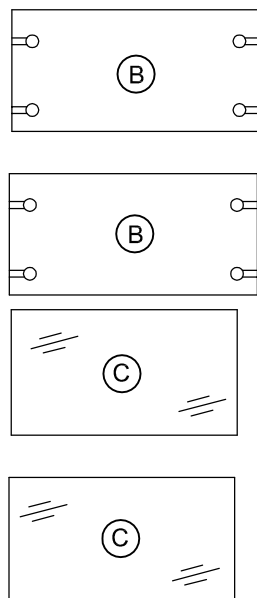
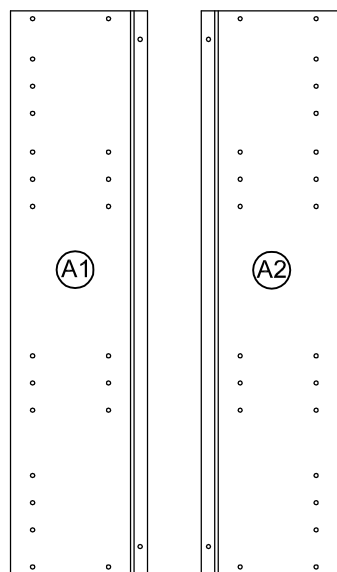

1.

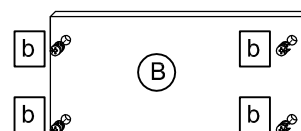
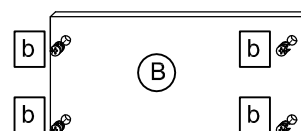
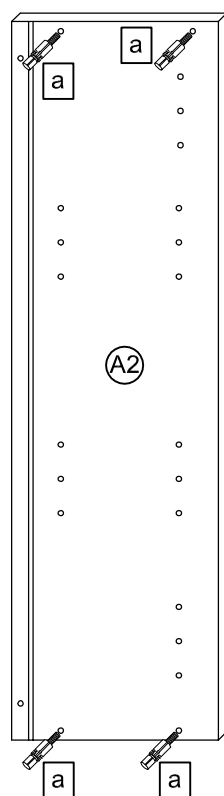
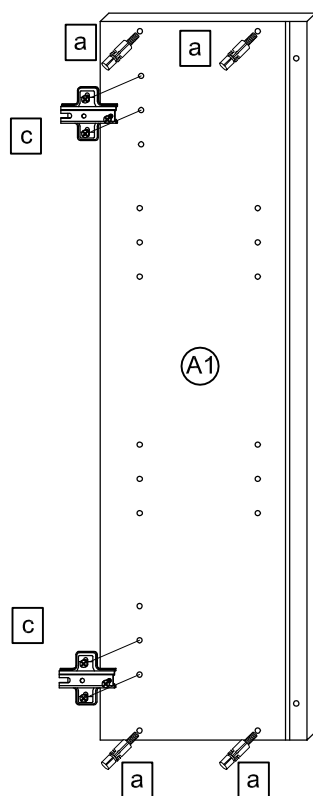
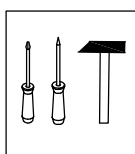

2.

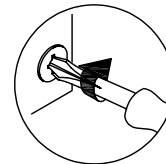
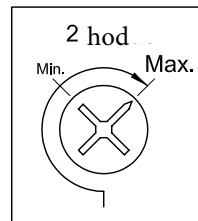
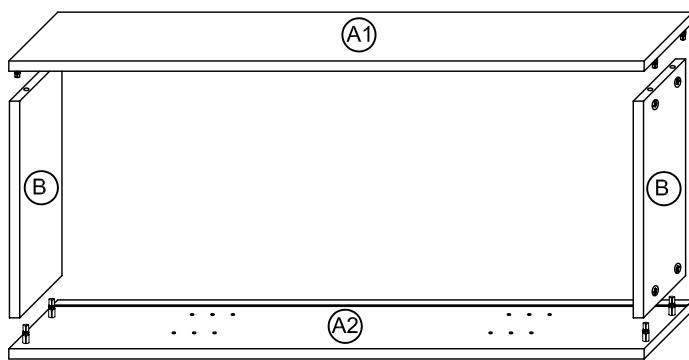
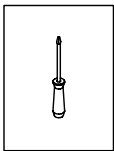

3.

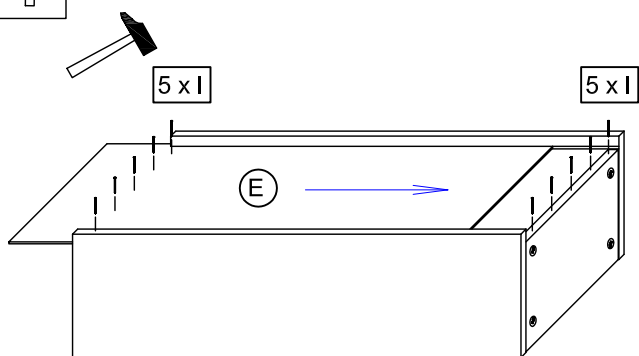
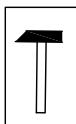

4.

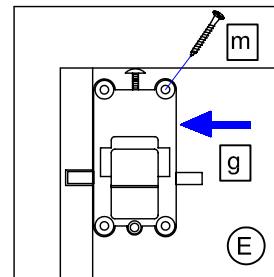
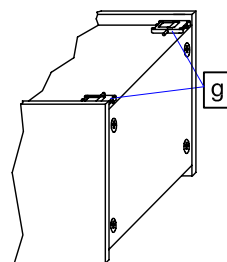
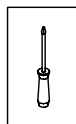

5.

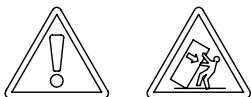
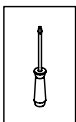

T9

Nechte skříňku namontovat pouze kvalifikovaným osobám s montážním materiálem vhodným pro stěnu.

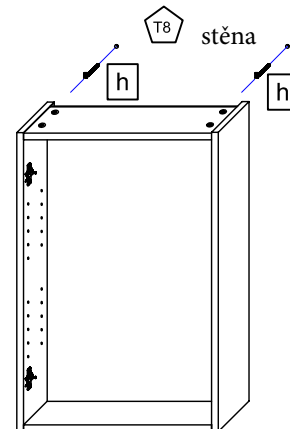
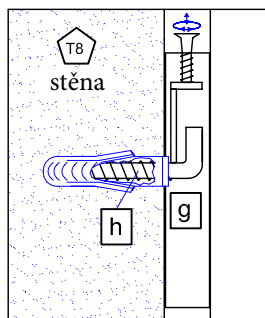

T5

Vystříhnete štítek, který je umístěn vpravo dole, a nalepte jej na zadní stranu (ne páskou).

PELIPAL GmbH  
Industriestrasse 2

33189 Schlangen  
Germany

6. 

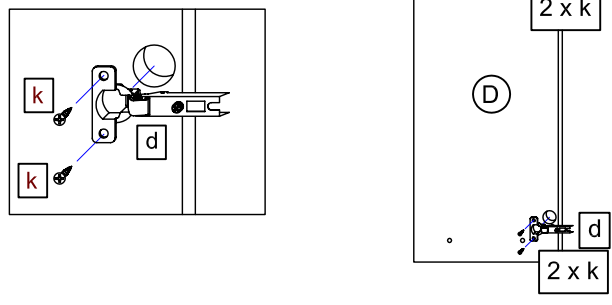

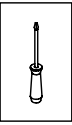
7. 

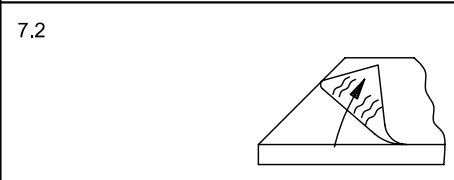
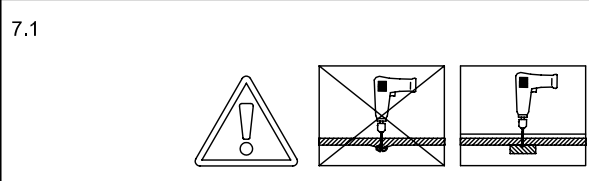
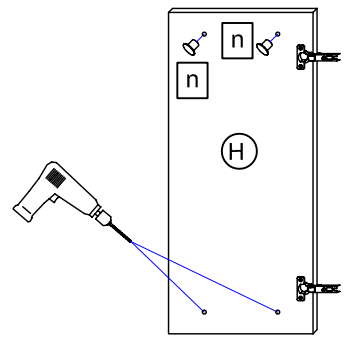

**T10** U frontu s vysokým leskem nejdříve odstraňte ochrannou fólii a poté nainstalujte rukojeť!

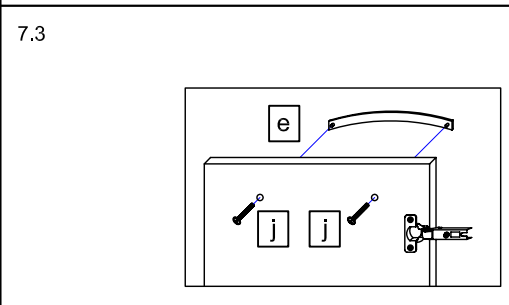

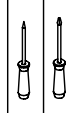
8. 

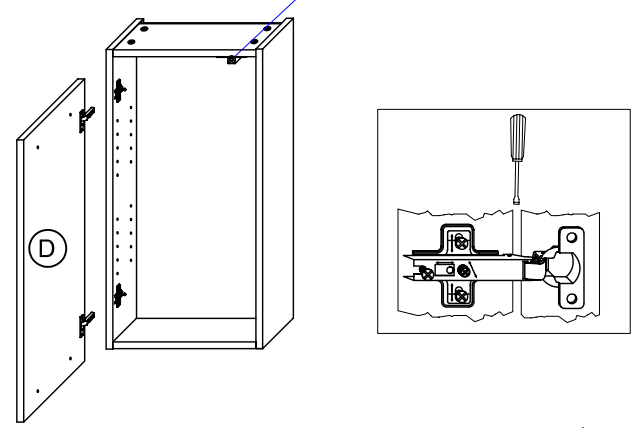
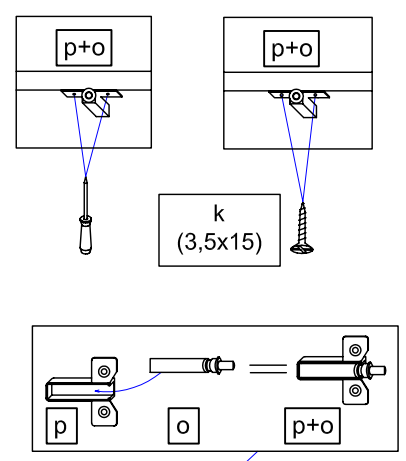

**T11** Při namontování dveří zaveďte háček do závěsu, otevřete jej až na doraz a potom jej pevně přišroubujte.

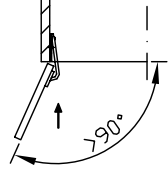
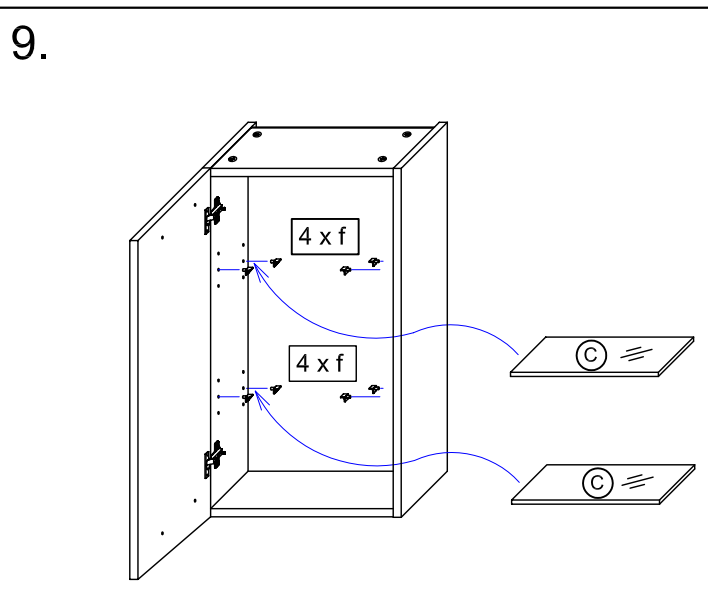
**T12** Nábytek prosím vyčistěte pouze vlhkým hadříkem.