





 A 24	 D2 12	 C 12	 F4 6	 E 12	 O11 1
-------------	--------------	-------------	-------------	-------------	--------------

1.

 #8x30mm A	 L=20mm D2	 #15/12mm C	 0,05 O11
24	12	12	1

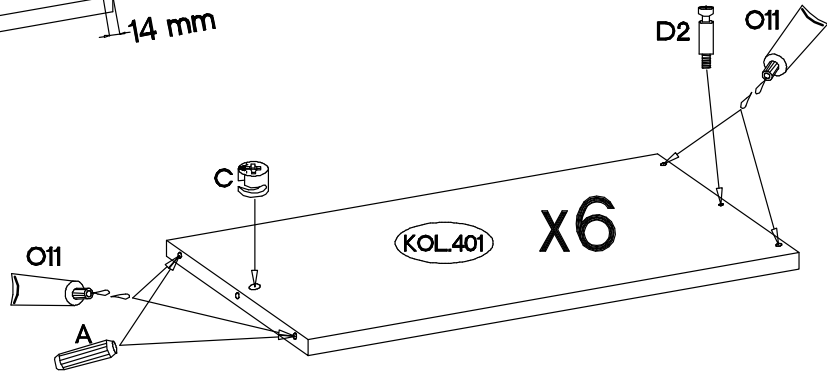
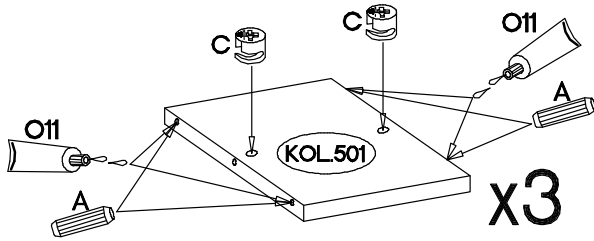
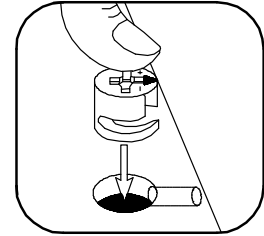
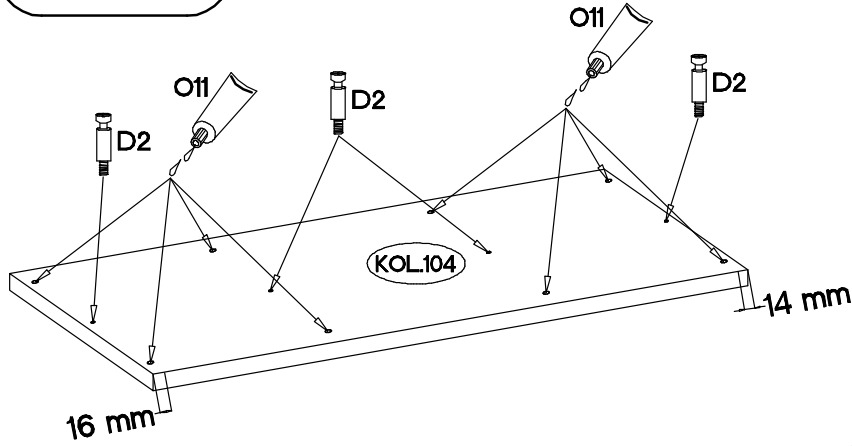
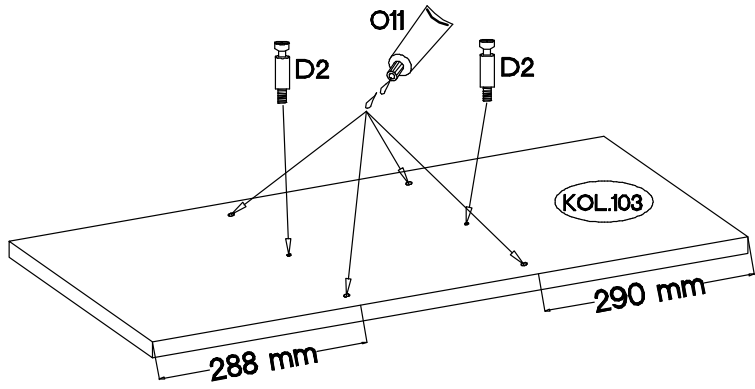
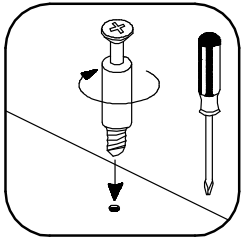

2.

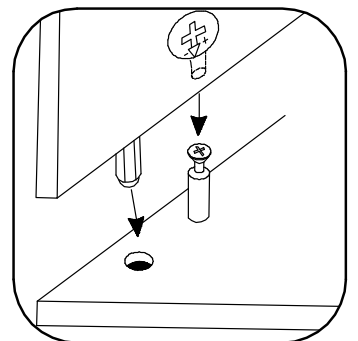
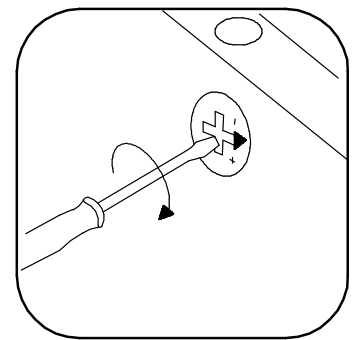
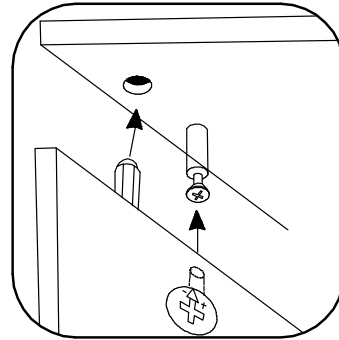
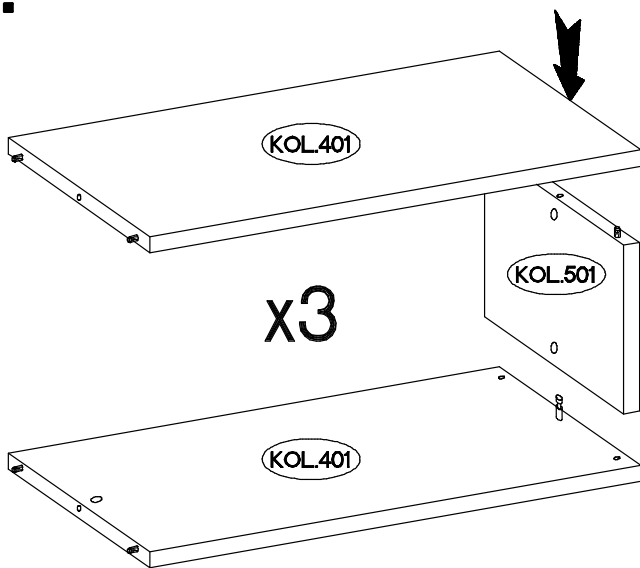

3.

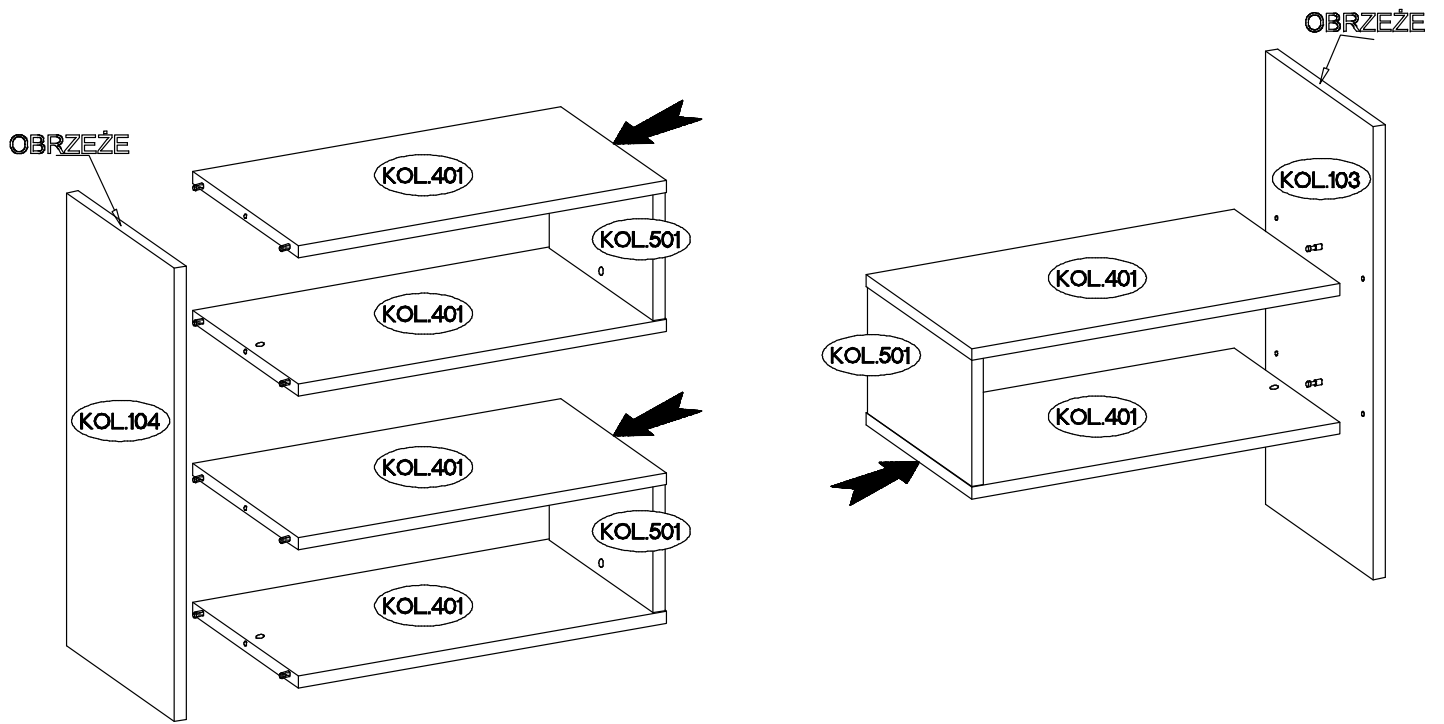

4.

