

**MORE 01**

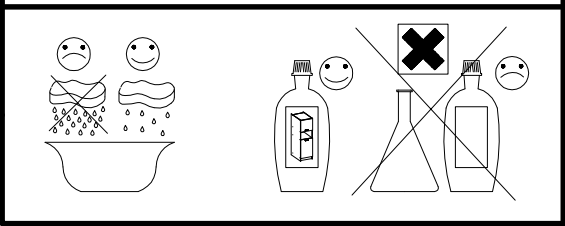

MONTÁŽNÍ NÁVOD/MONTAZHNY NÁVOD

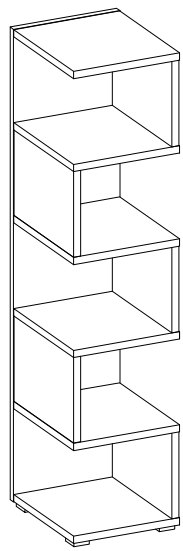
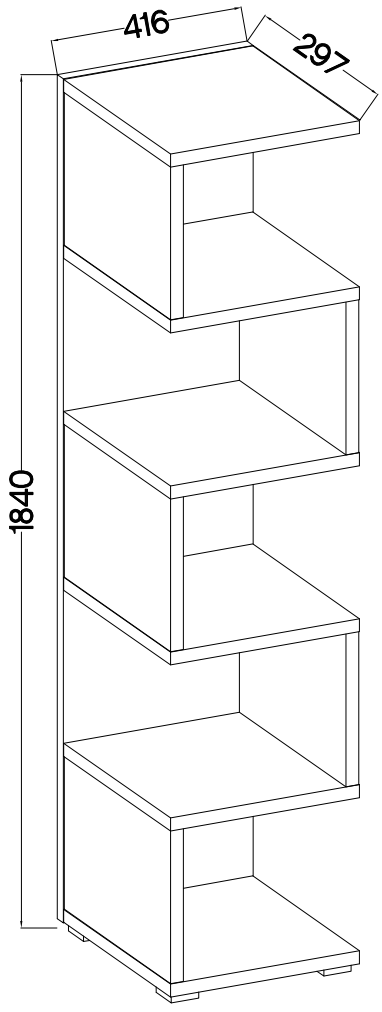

$\text{H}10 \times 50 \text{mm}$ O7	$\text{H}5.0 \times 70 \text{mm}$ P29	$\text{H}20$ E11						
1	1	1						
$\text{H}8 \times 30 \text{mm}$ A	$6.4 \times 50 \text{mm}$ B	$\text{H}5 / \text{H}8 \text{mm}$ C6	$L=20 \text{mm}$ D2	E	$60 \times 40 \times 20$ F1	$\text{H}4.0 \times 25 \text{mm}$ P14	O	
20	12	10	10	10	4	8	1	

**ISM-RMO-001**

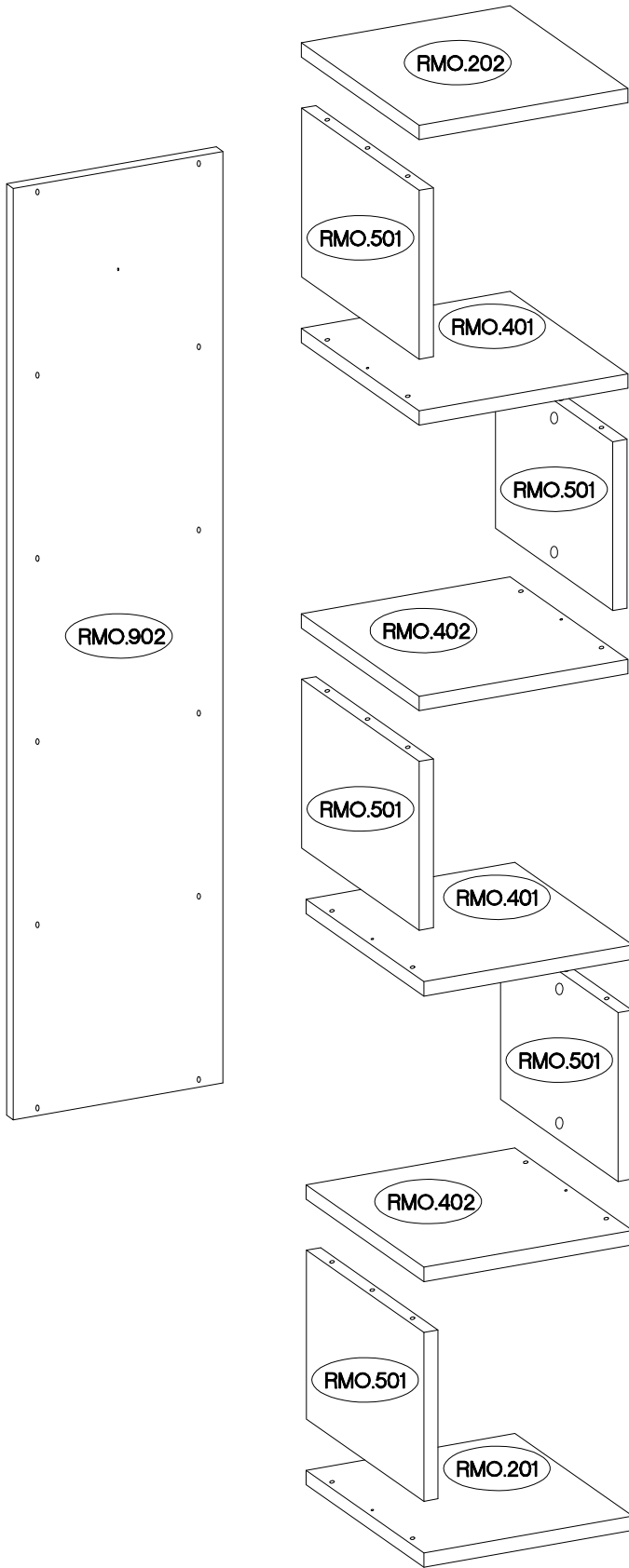

- RMO.201
- RMO.202
- RMO.401
- RMO.402

Colli	Ersatzteil Nummer	Dimension
Colli 1/1	RMO.201	414x281x28
	RMO.202	414x281x28
	RMO.401 x 2	414x281x28
	RMO.402 x 2	414x281x28
	RMO.501 x 5	330x280x28
	RMO.902	1820x416x16

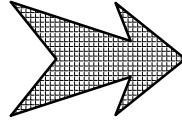
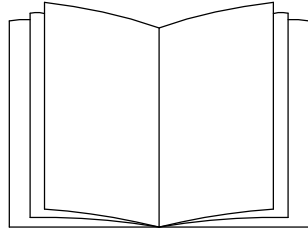
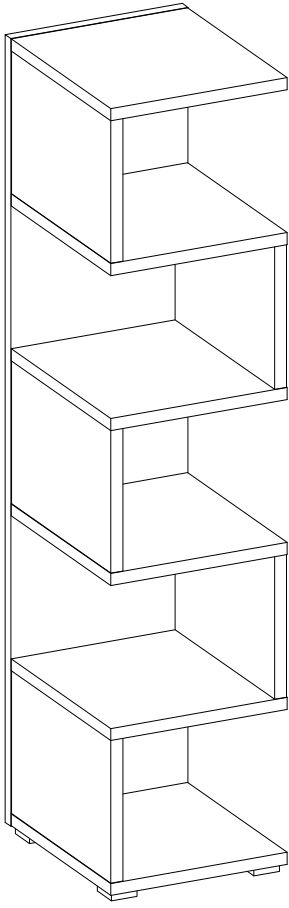

1 — 17

35

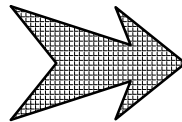
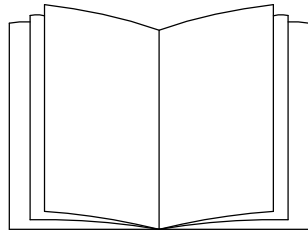
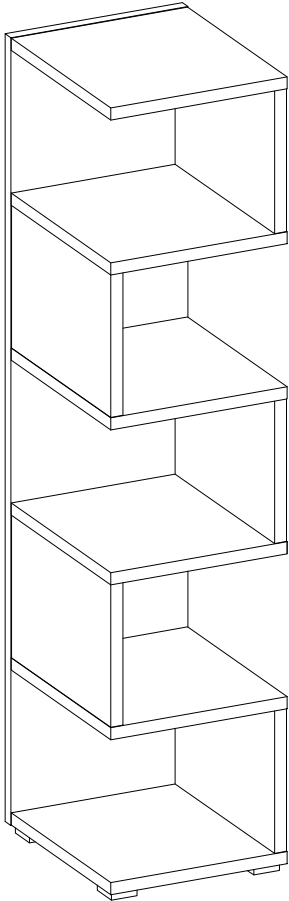

18 — 34

35

1

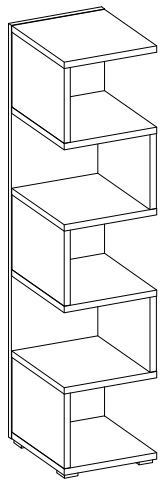

$\varnothing 8 \times 30 \text{mm}$  <b>A</b> 20	$\varnothing 15/18 \text{mm}$  <b>C6</b> 10	$L=20 \text{mm}$  <b>D2</b> 10	$60 \times 40 \times 20$  <b>F1</b> 4	$\varnothing 4.0 \times 25 \text{mm}$  <b>P14</b> 8
---	--	---	--	--

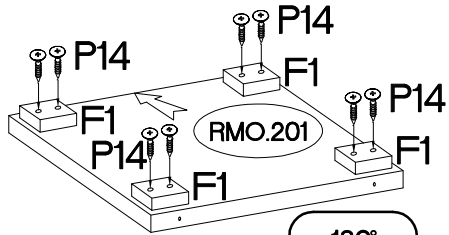
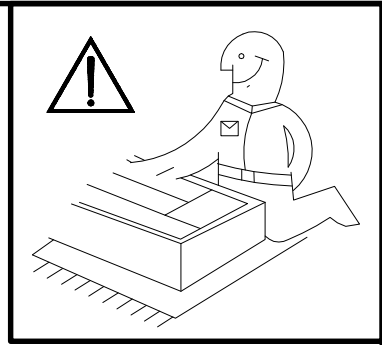

x1

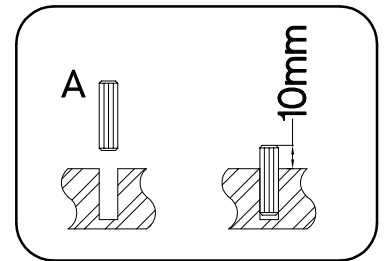
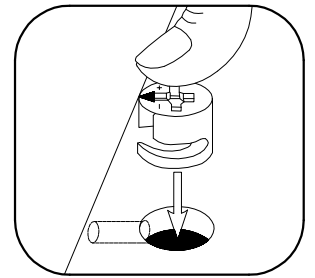
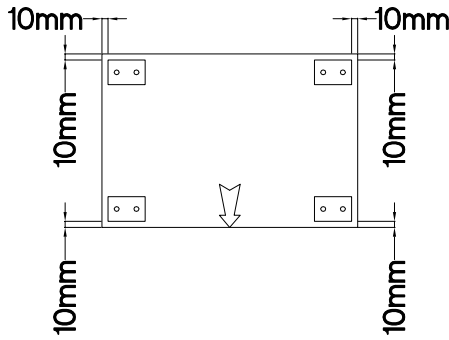
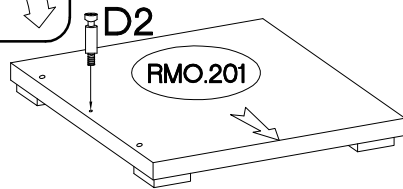
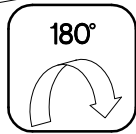

x1

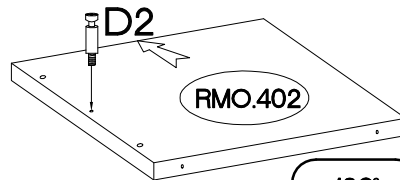
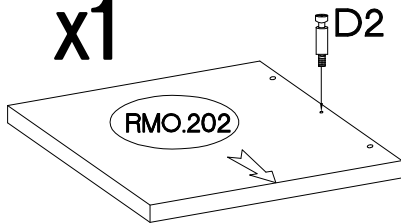

x2

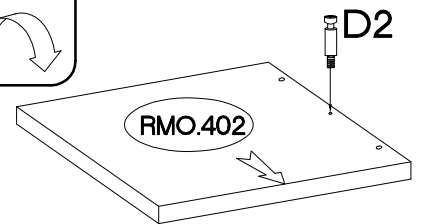
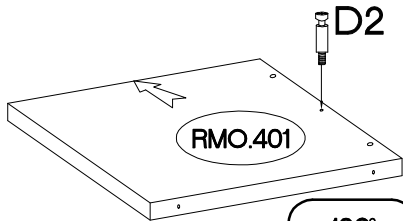
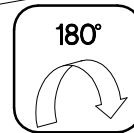

x2

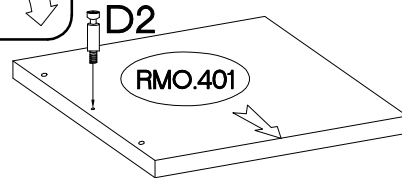
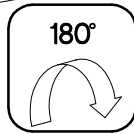

x5

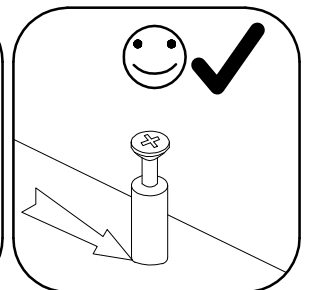
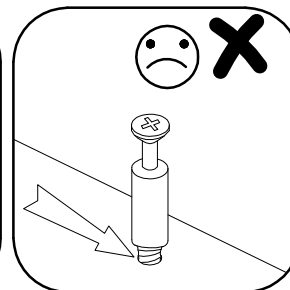
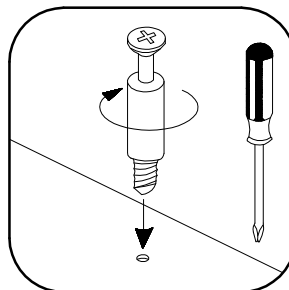
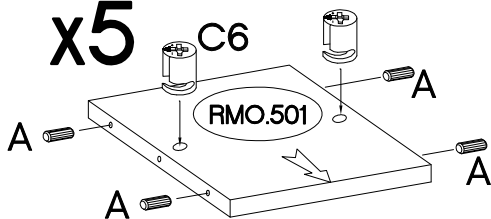

2

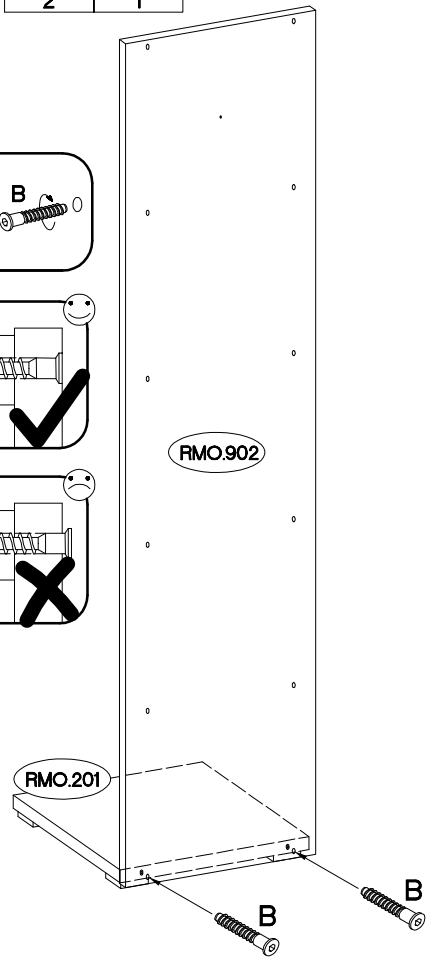
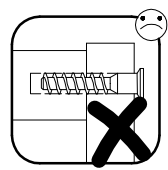
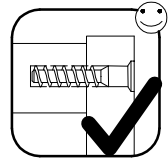
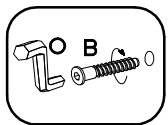
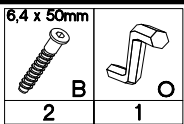

3

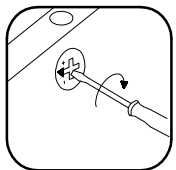
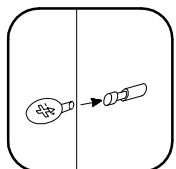
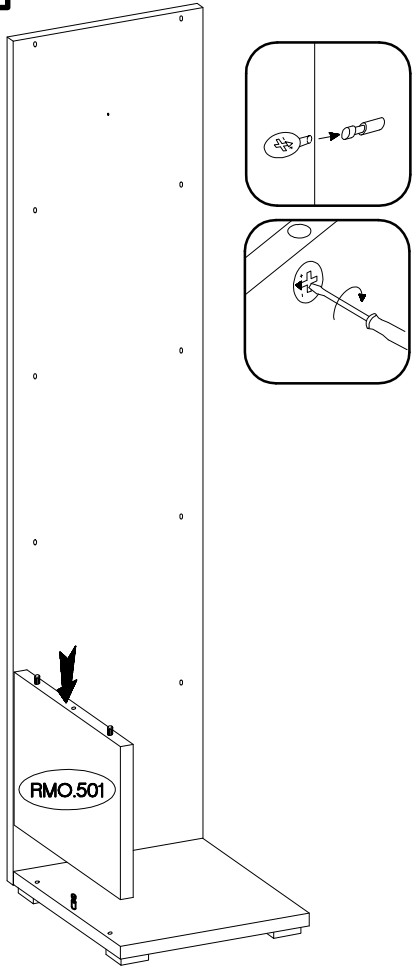

4

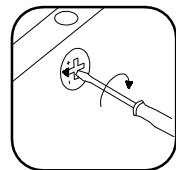
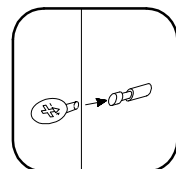
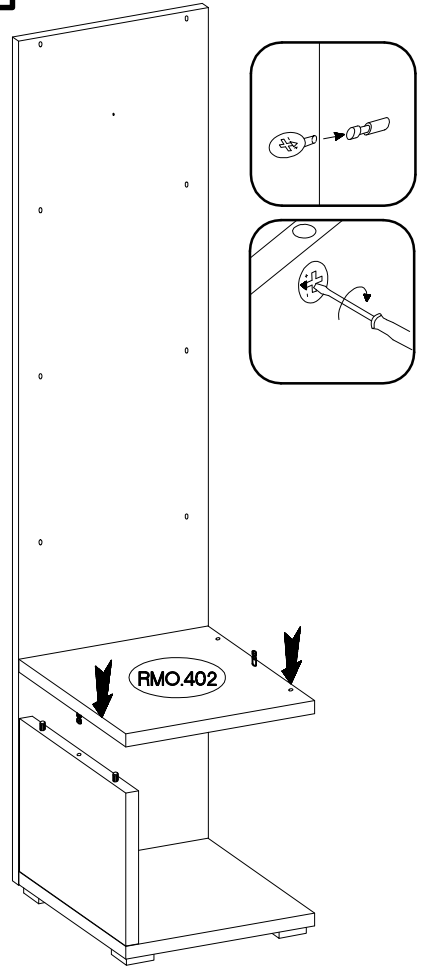

5

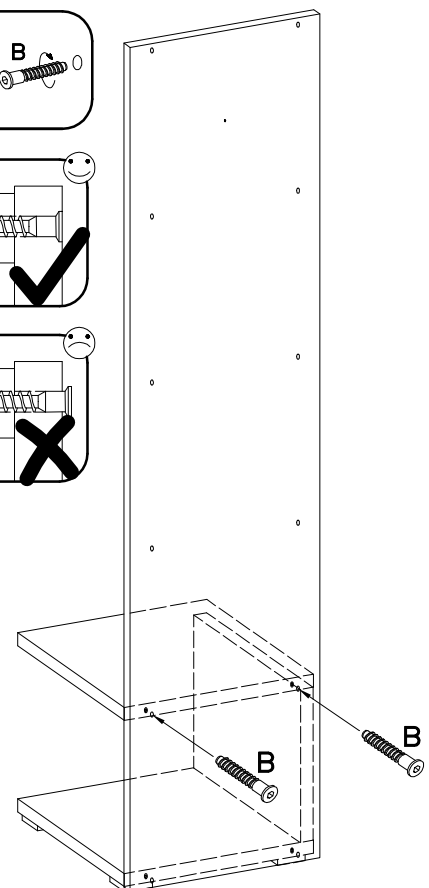
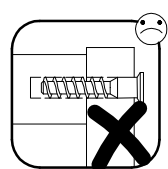
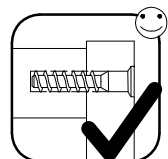
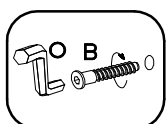
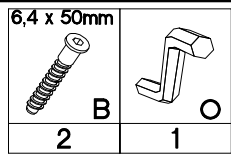

6

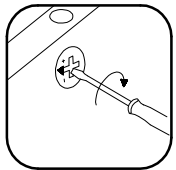
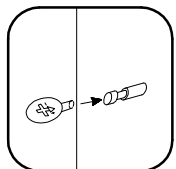

7

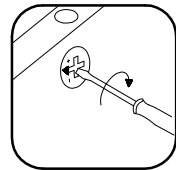
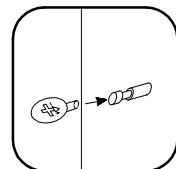
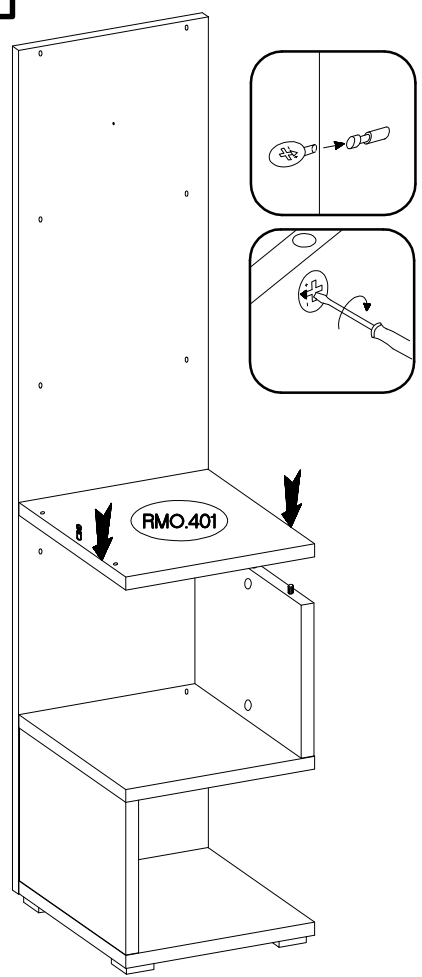

8

6,4 x 50mm



B



O

2

1

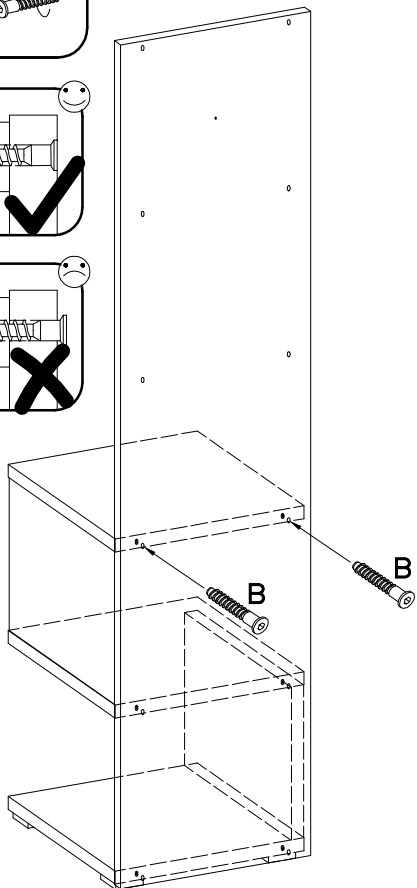
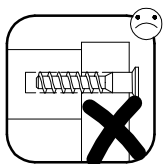
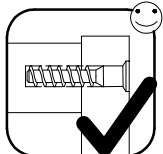
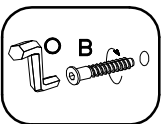

9

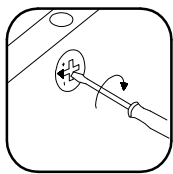
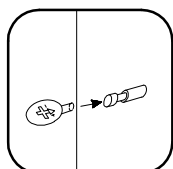
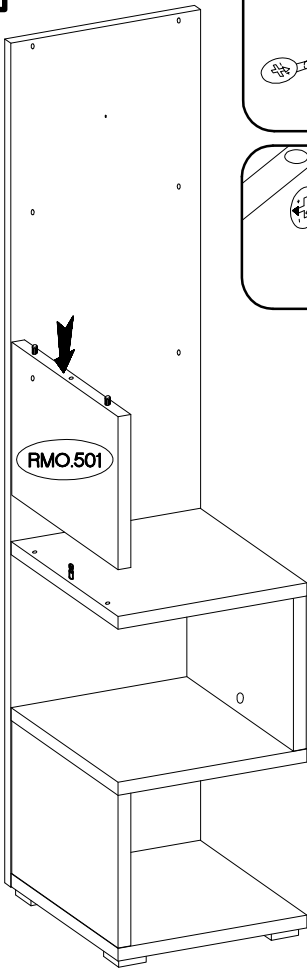

10

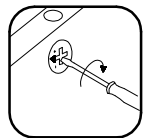
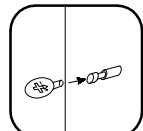
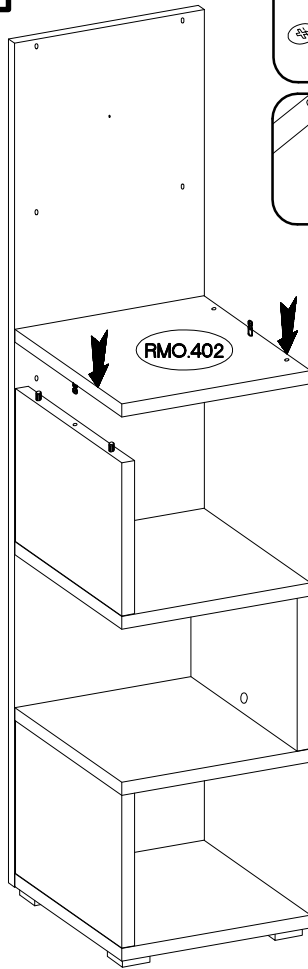

11

6,4 x 50mm



B



O

2

1

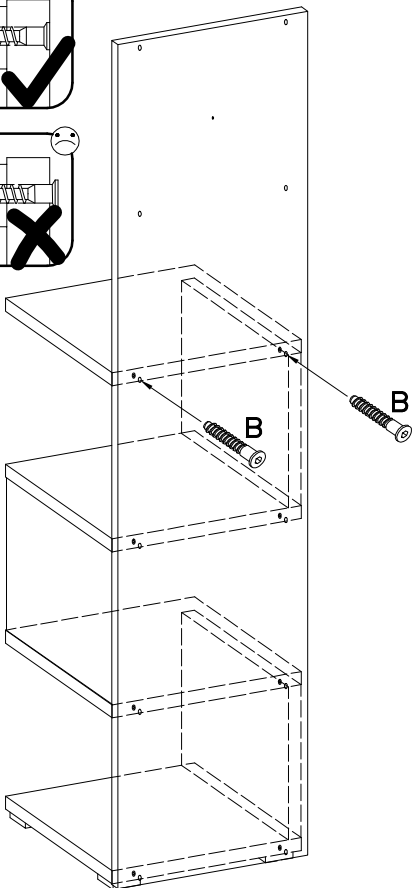
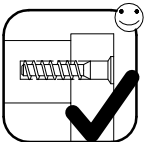
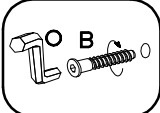

12

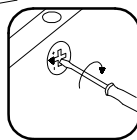
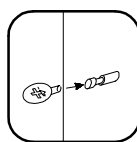
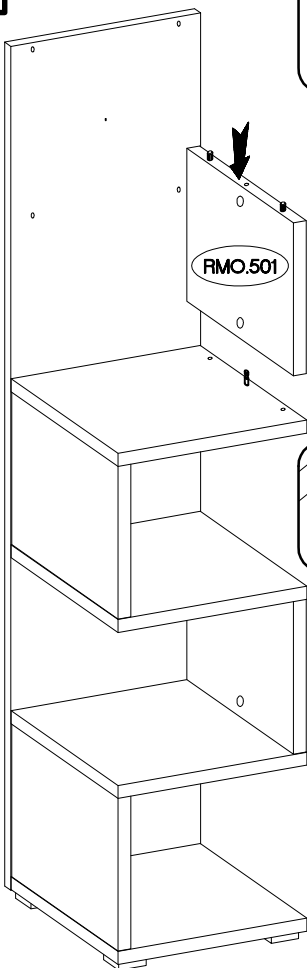

13

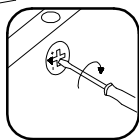
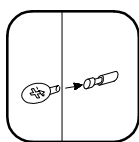
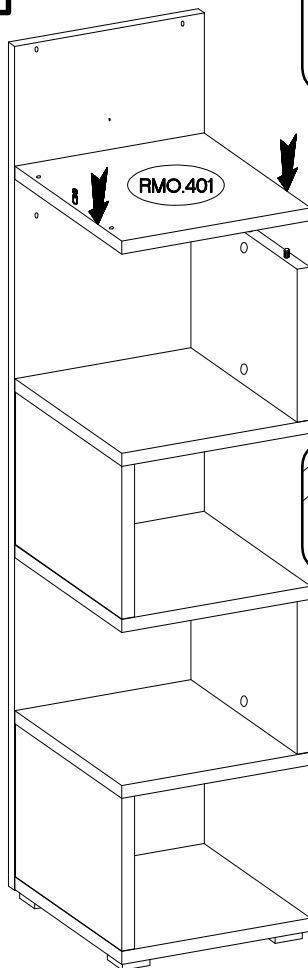

14

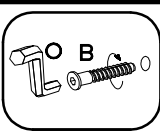

6,4 x 50mm

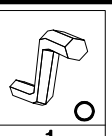
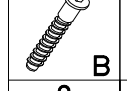

2

1

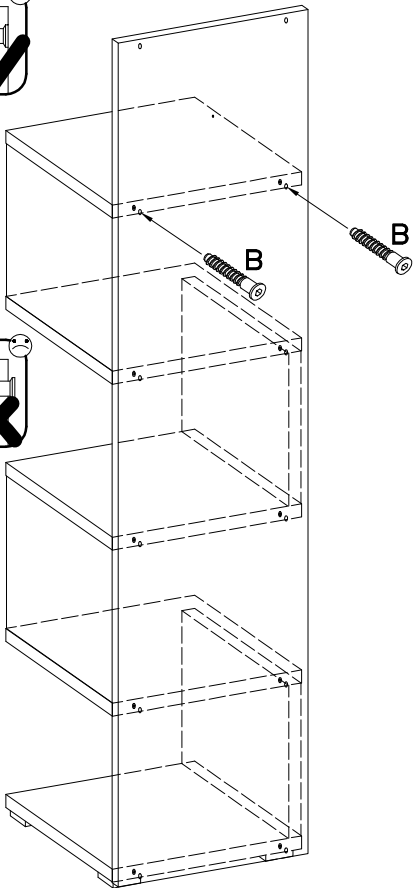

15

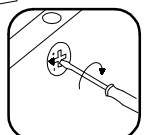
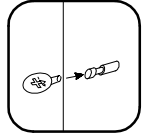
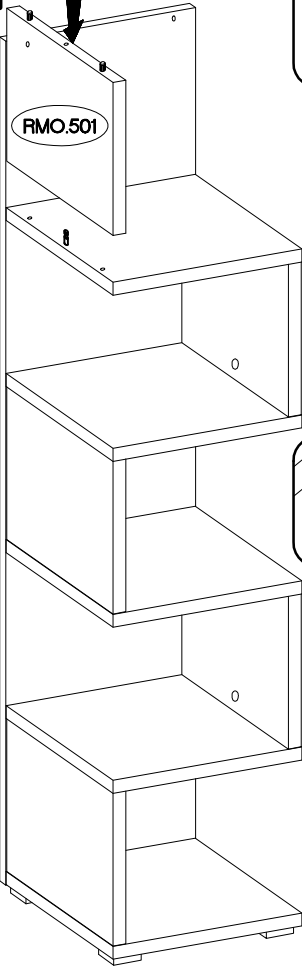

16

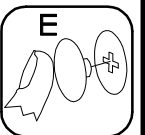
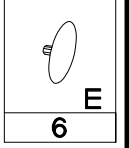
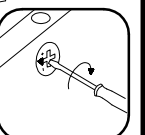
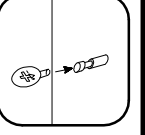
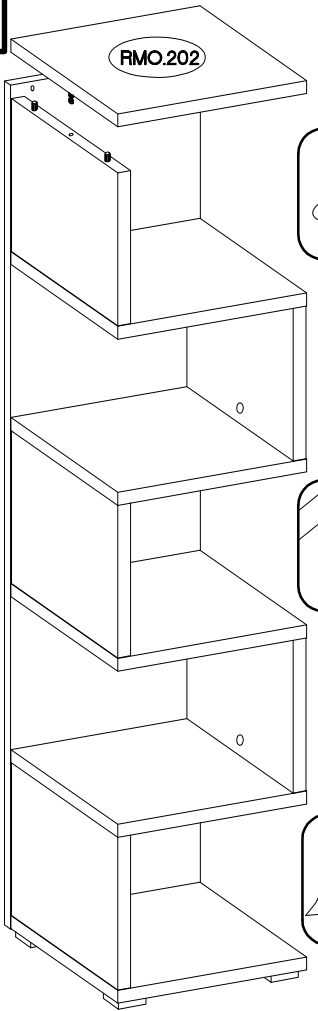

17

6,4 x 50mm

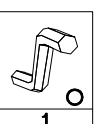
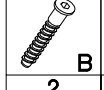



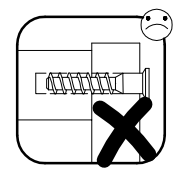
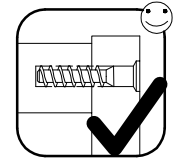
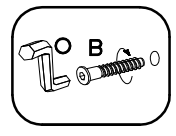
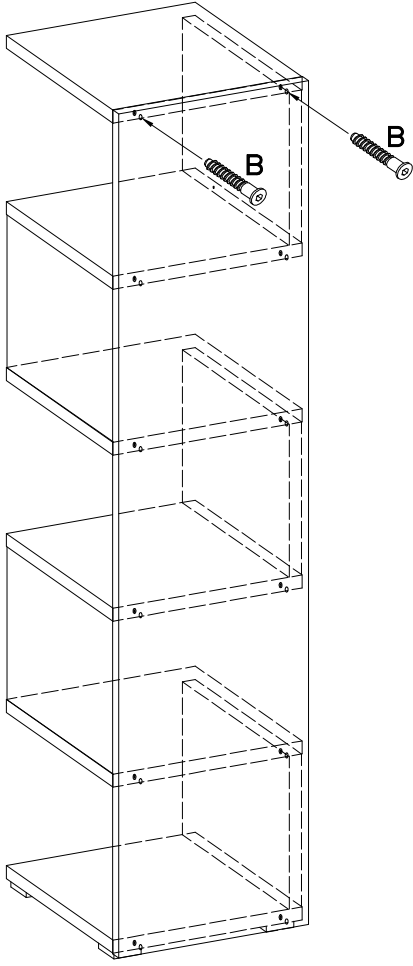

2

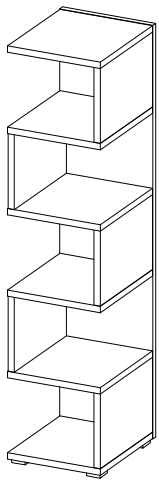
1



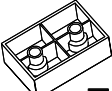

∅8x30mm	∅15/18mm	L=20mm	60x40x20	∅4.0x25mm
				
A	C6	D2	F1	P14
20	10	10	4	8

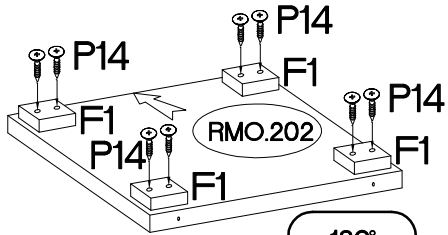
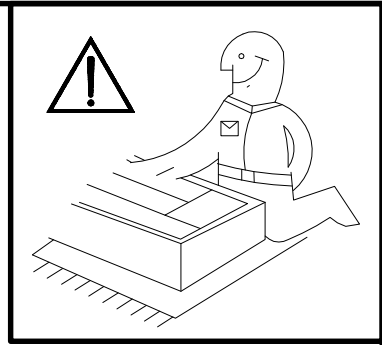

x1

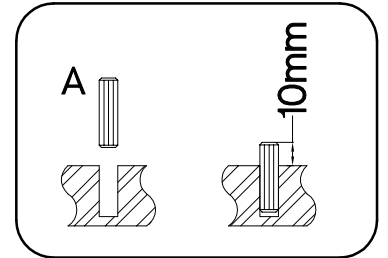
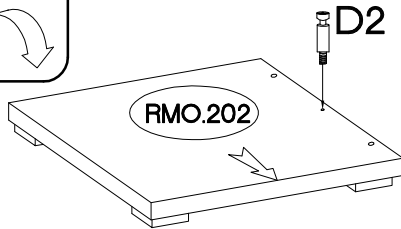
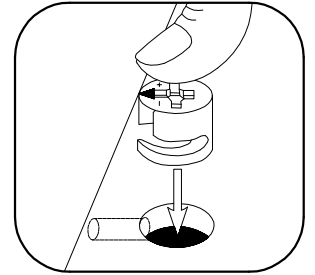
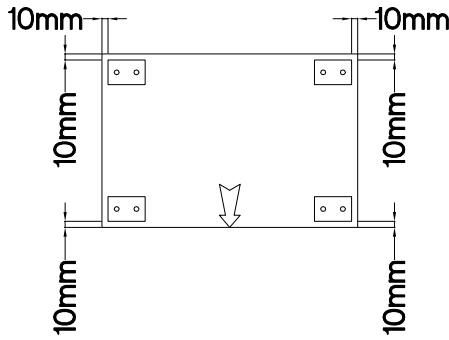
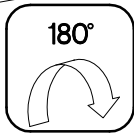

x1

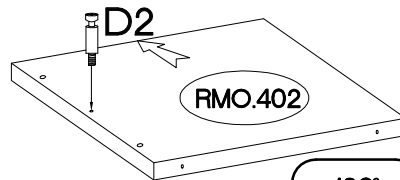
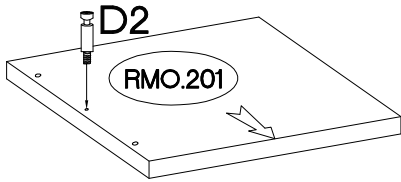

x2

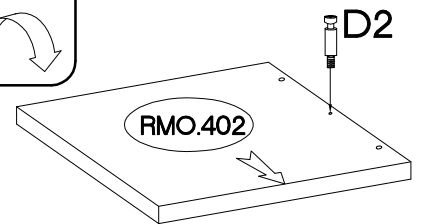
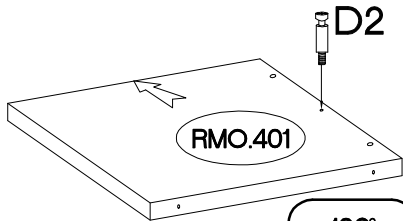
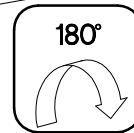

x2

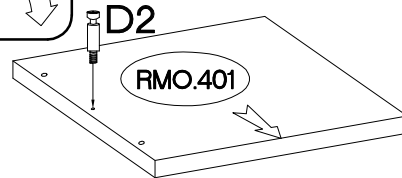
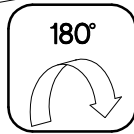

x5

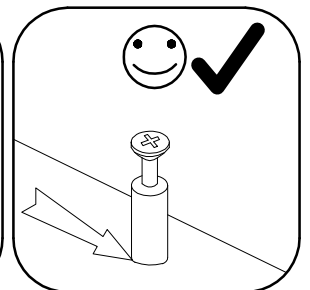
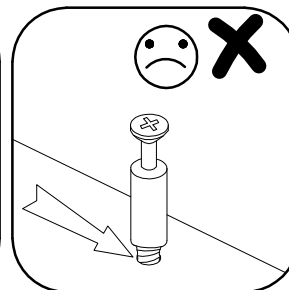
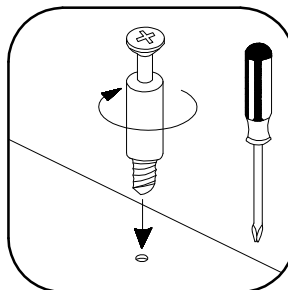
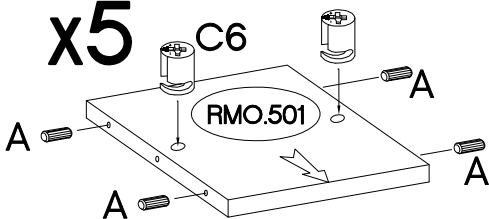

19

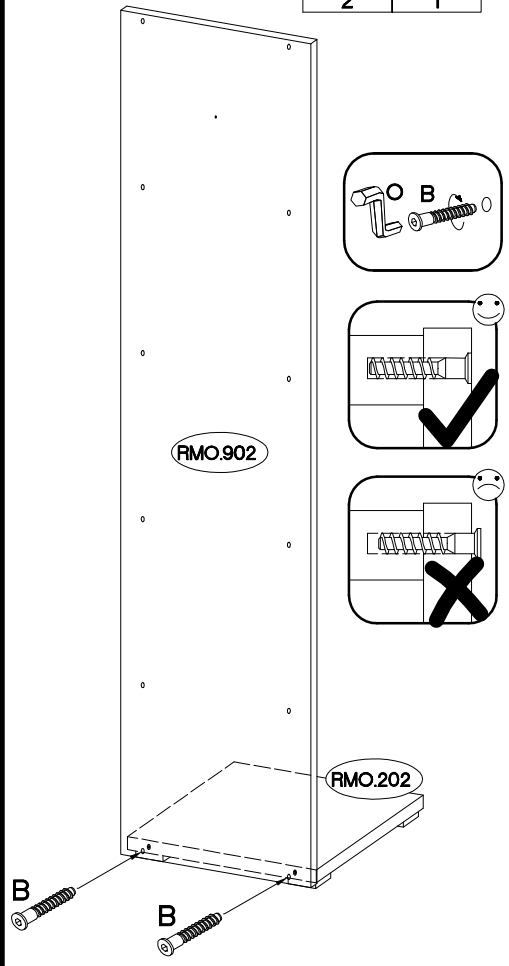
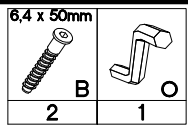

20

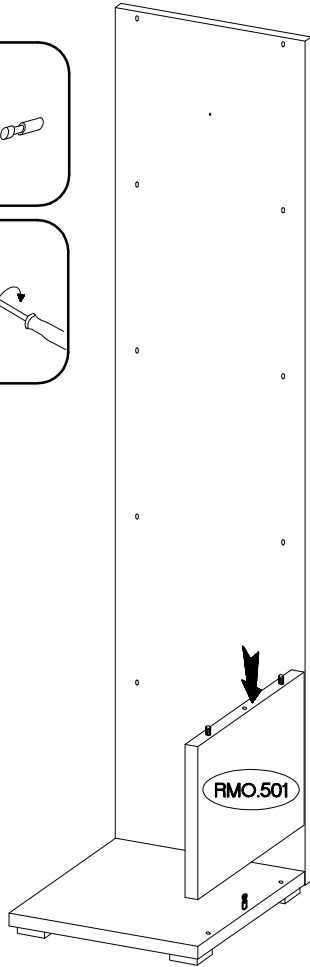
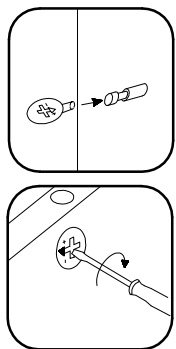

21

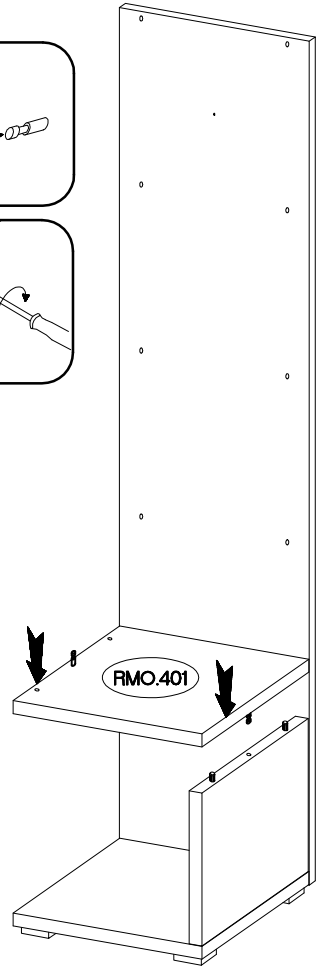
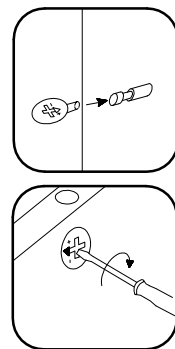

22

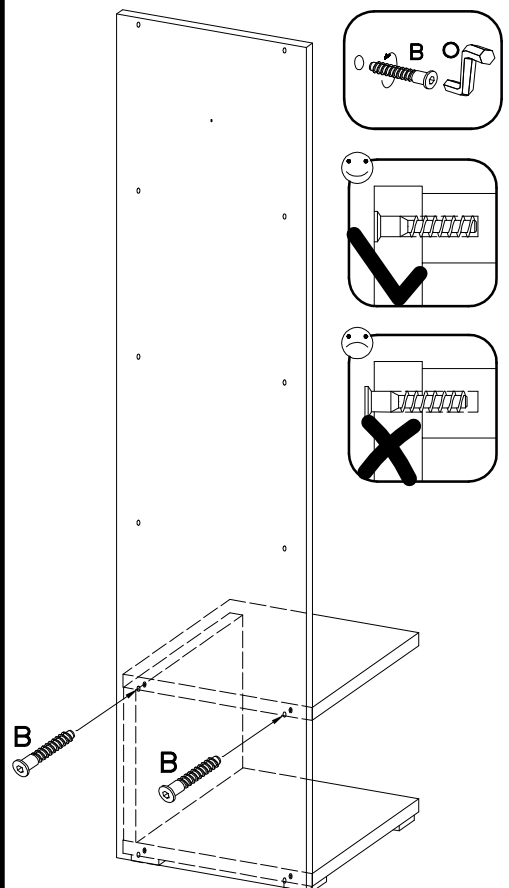
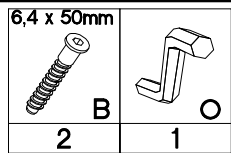

23

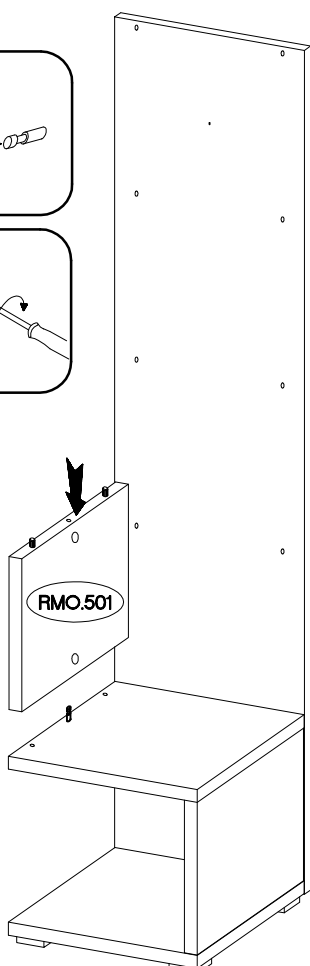
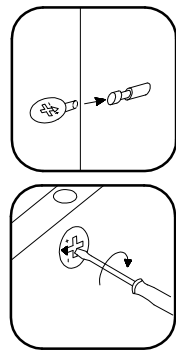

24

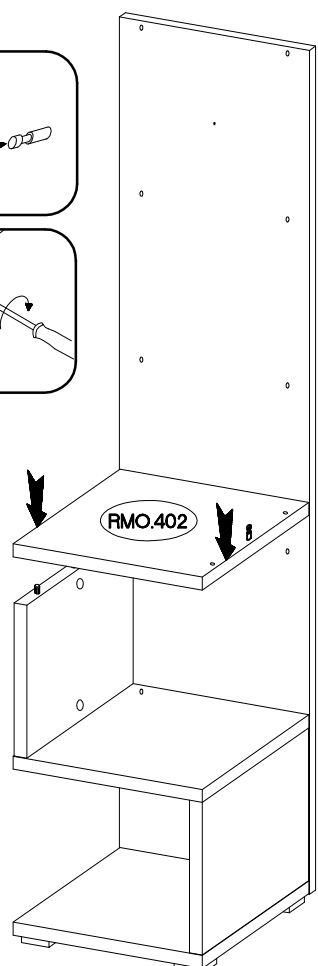
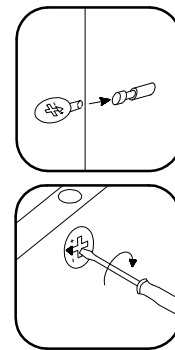

25

6,4 x 50mm



B

O

2

1

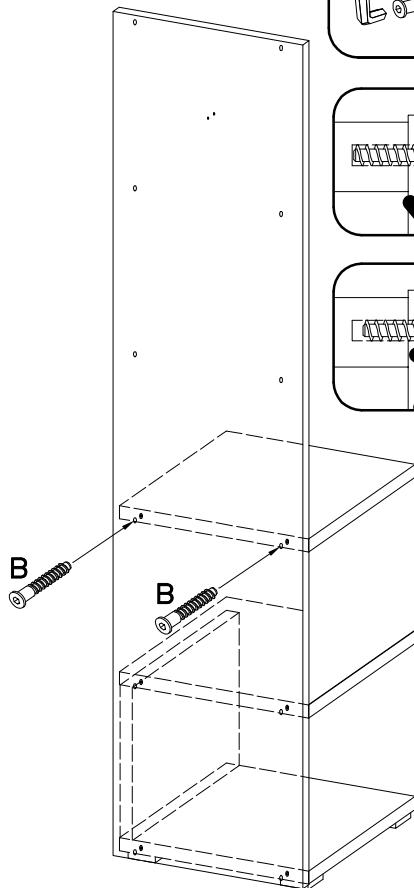
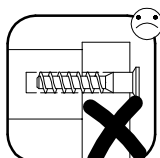
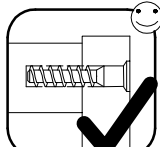
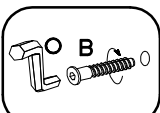

26

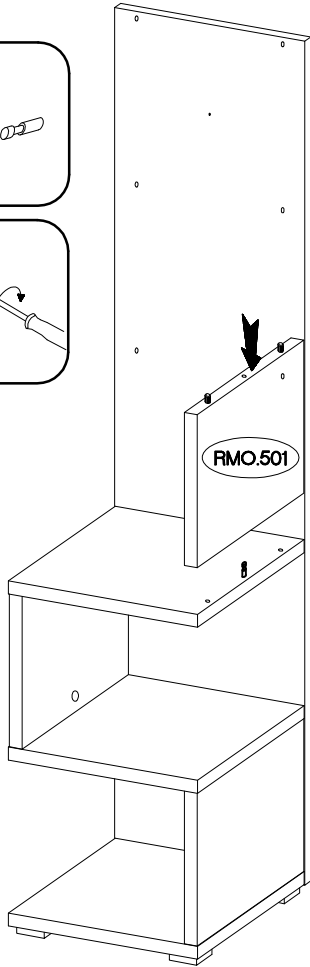
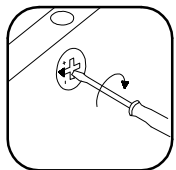
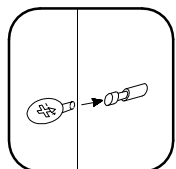

27

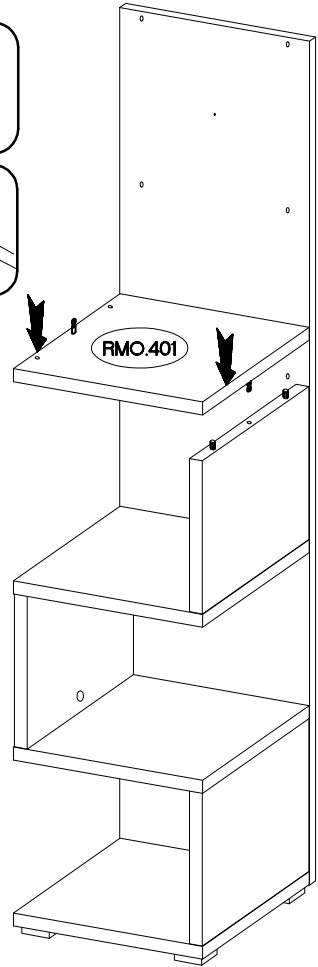
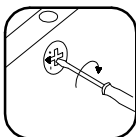
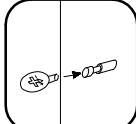

28

6,4 x 50mm



B

O

2

1

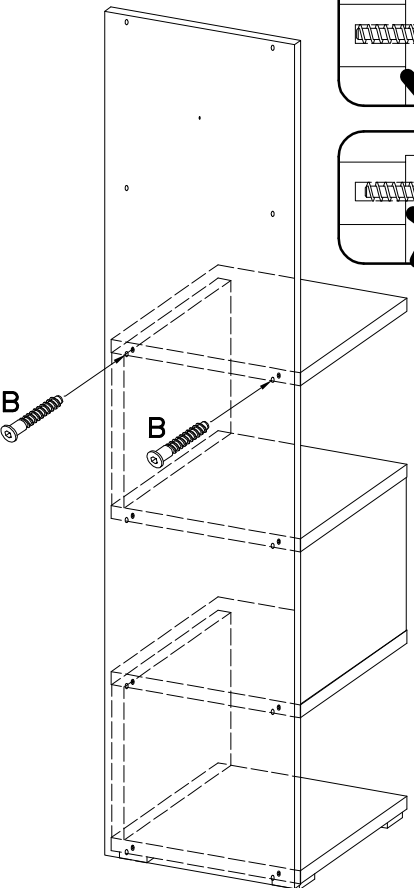
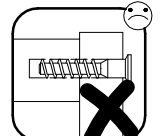
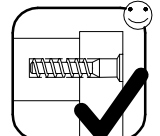
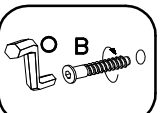

29

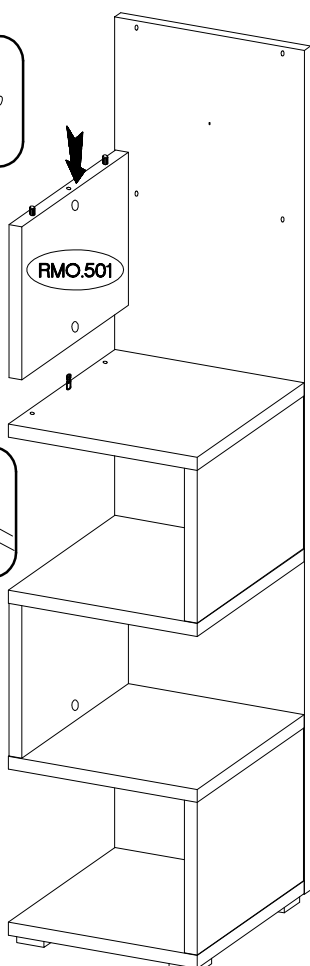
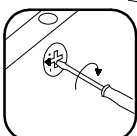
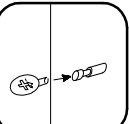

30

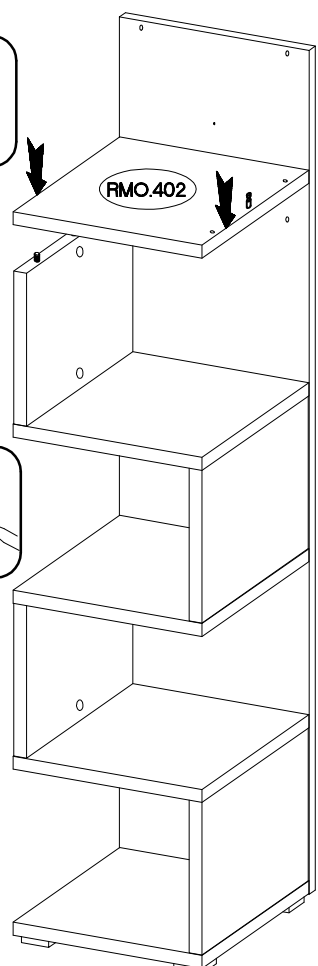
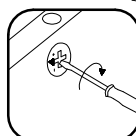
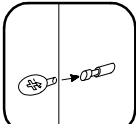

31

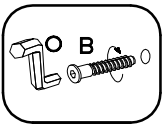

6,4 x 50mm



2

1

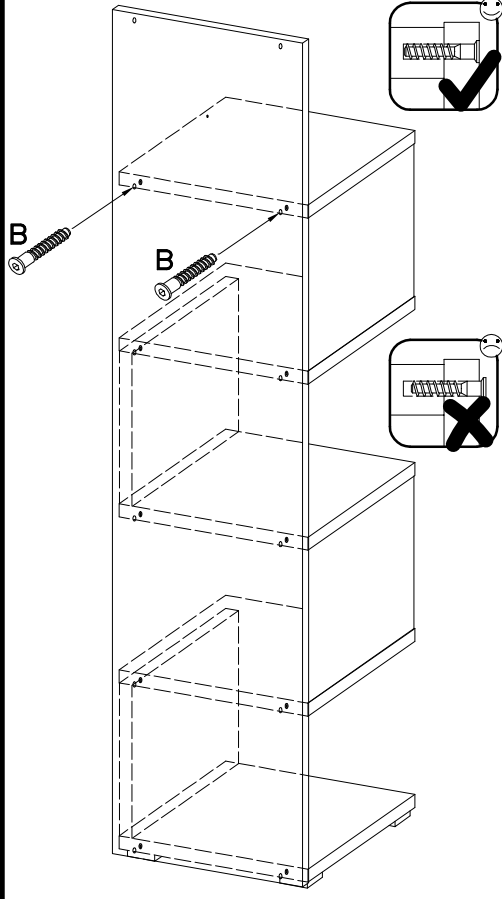

32

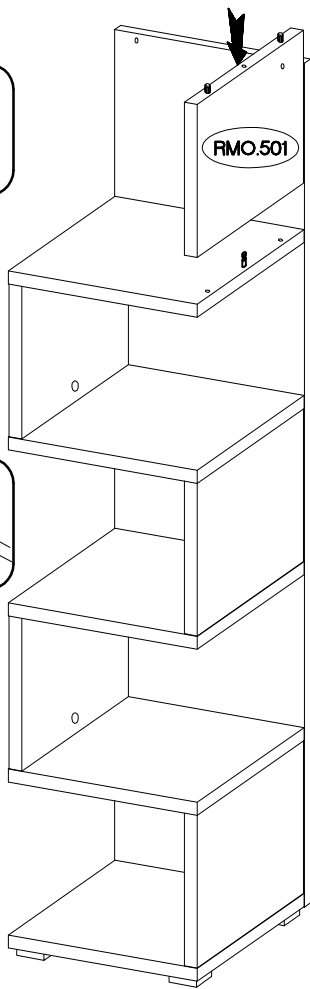
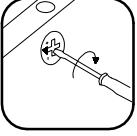
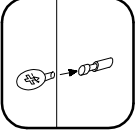

33

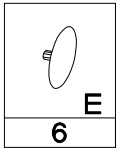
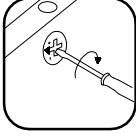
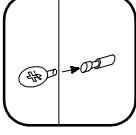

6

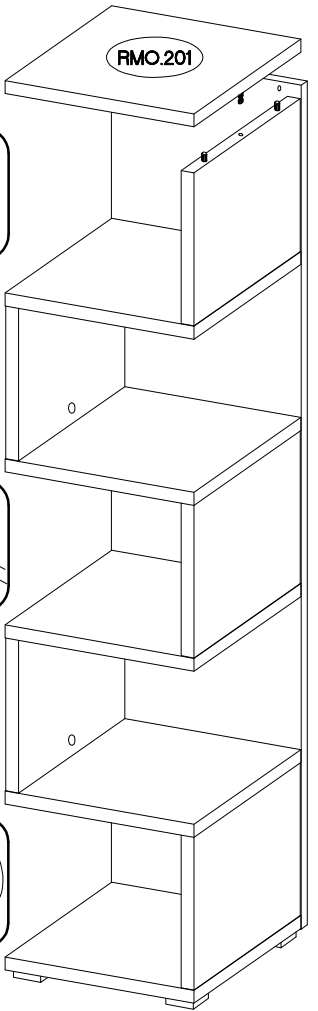
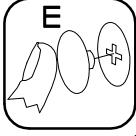

34

6,4 x 50mm





2

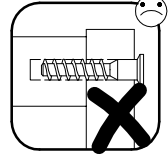
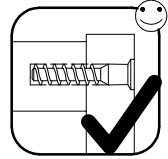
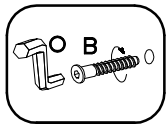
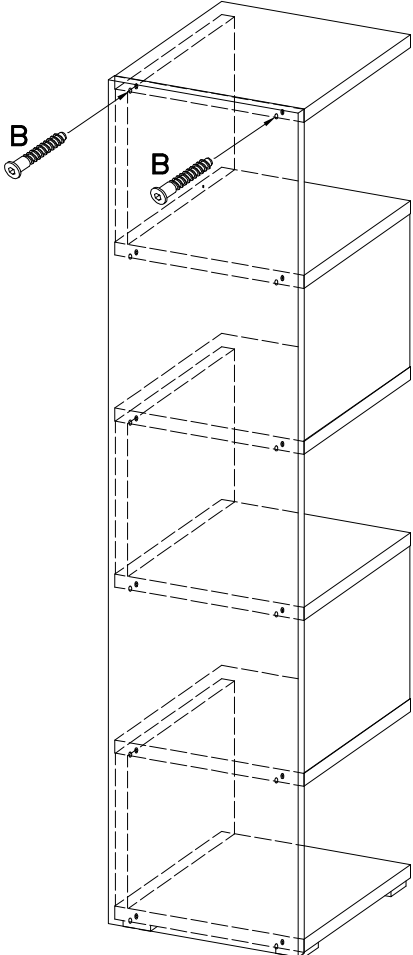

1



 #10x50mm O7 1	 #5.0x70mm P29 1	 #20 E11 1
--	--	--

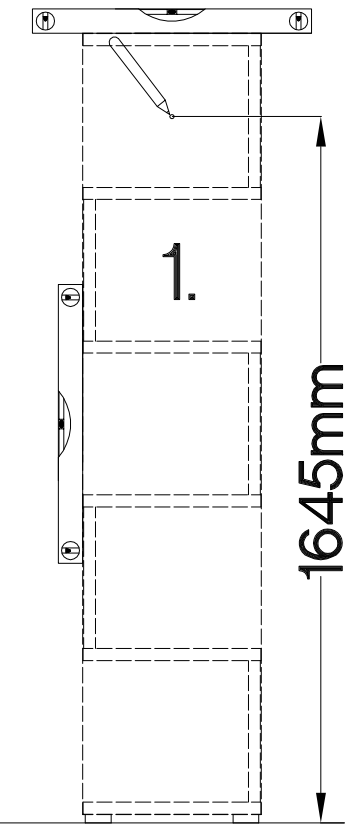
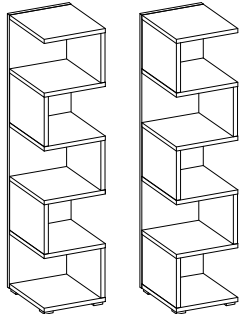

Ø10mm

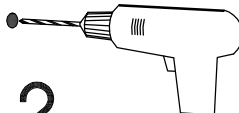

2.

O7

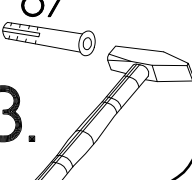

3.

