

240 min

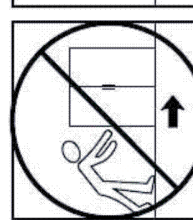

LE TRI + FACILE

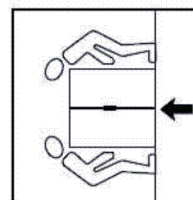
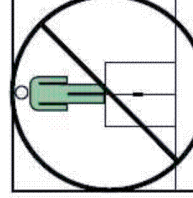
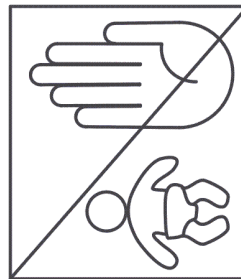
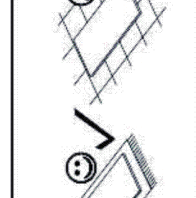
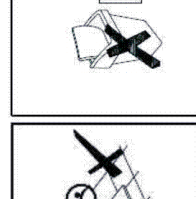
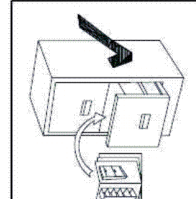
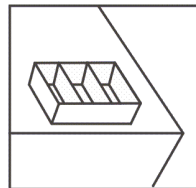
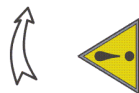
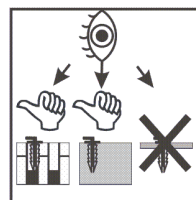
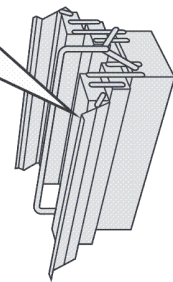
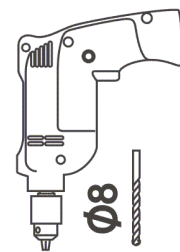
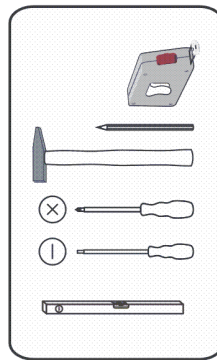
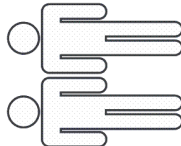

FR

Pensez à donner ou recycler.



ou



ou



Déchèterie

<https://quefairedemesdechets.fr>

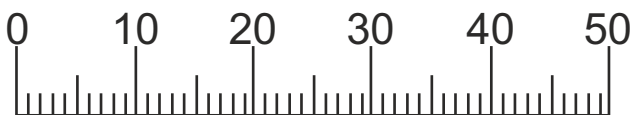
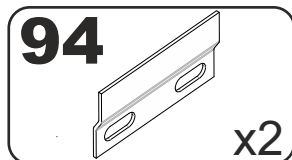
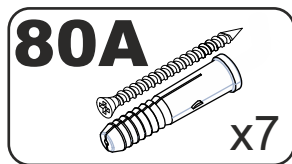
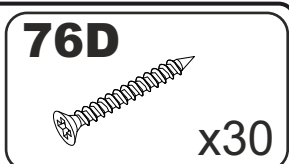
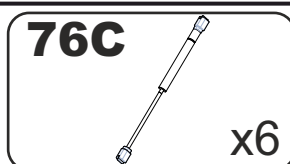
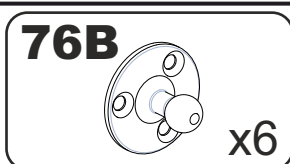
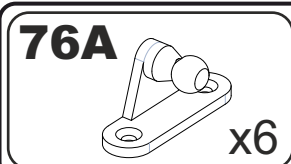
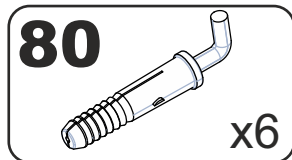
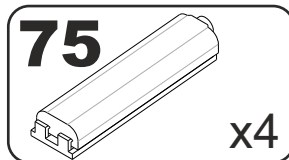
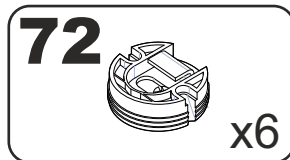
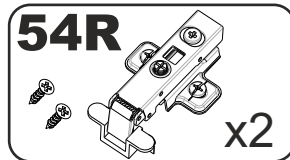
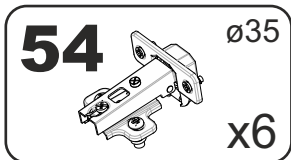
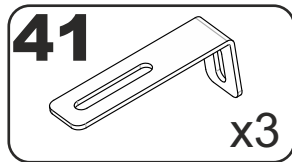
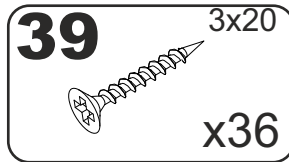
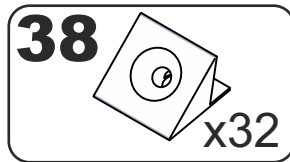
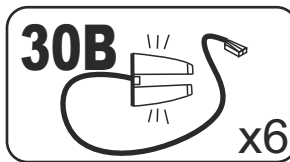
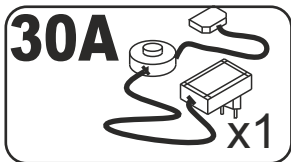
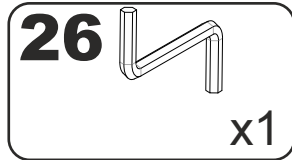
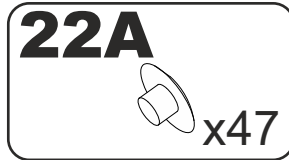
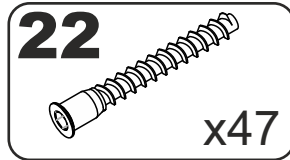
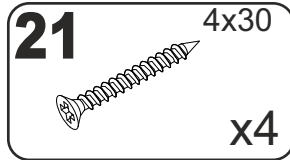
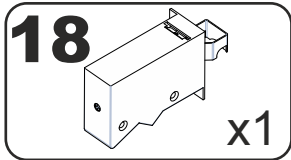
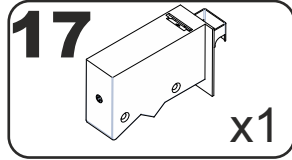
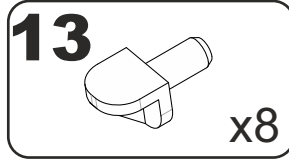
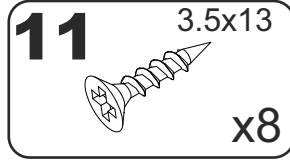
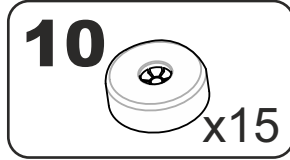
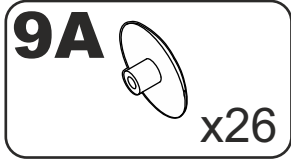
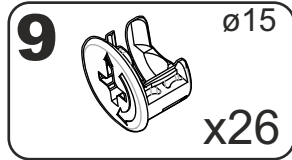
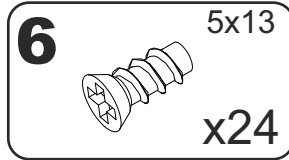
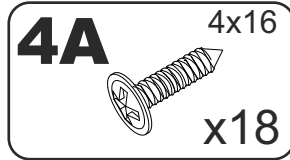
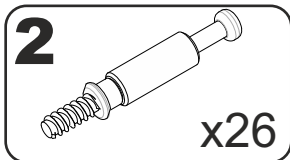
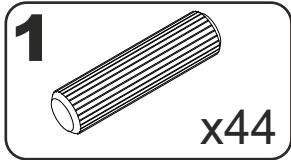
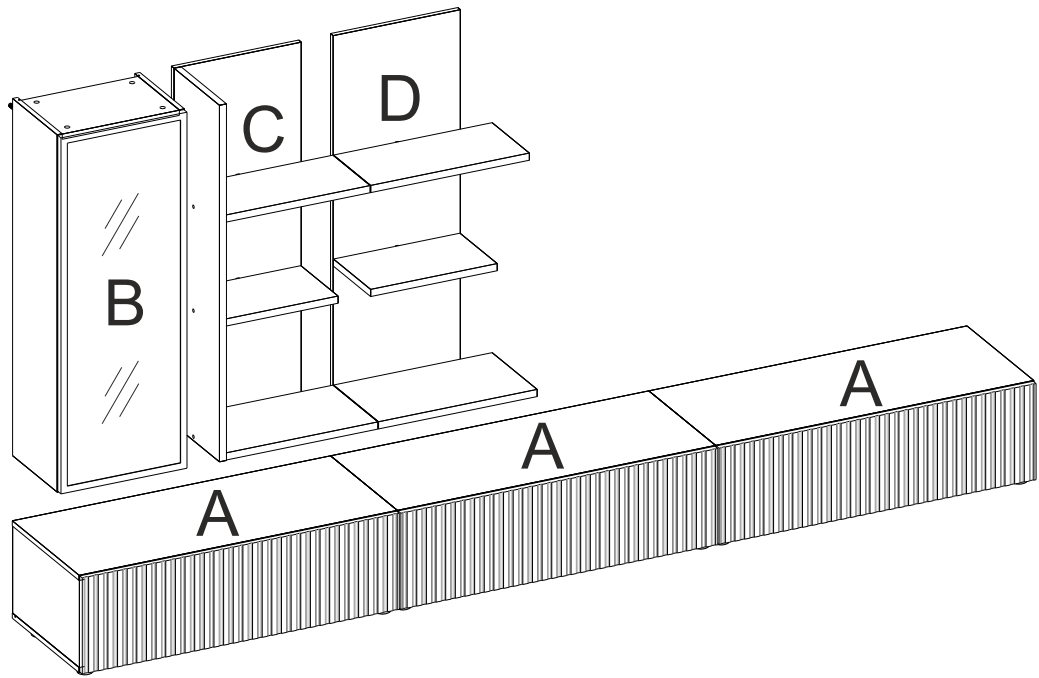
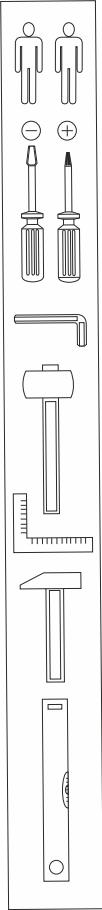

A

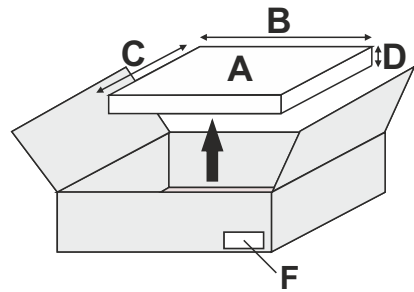
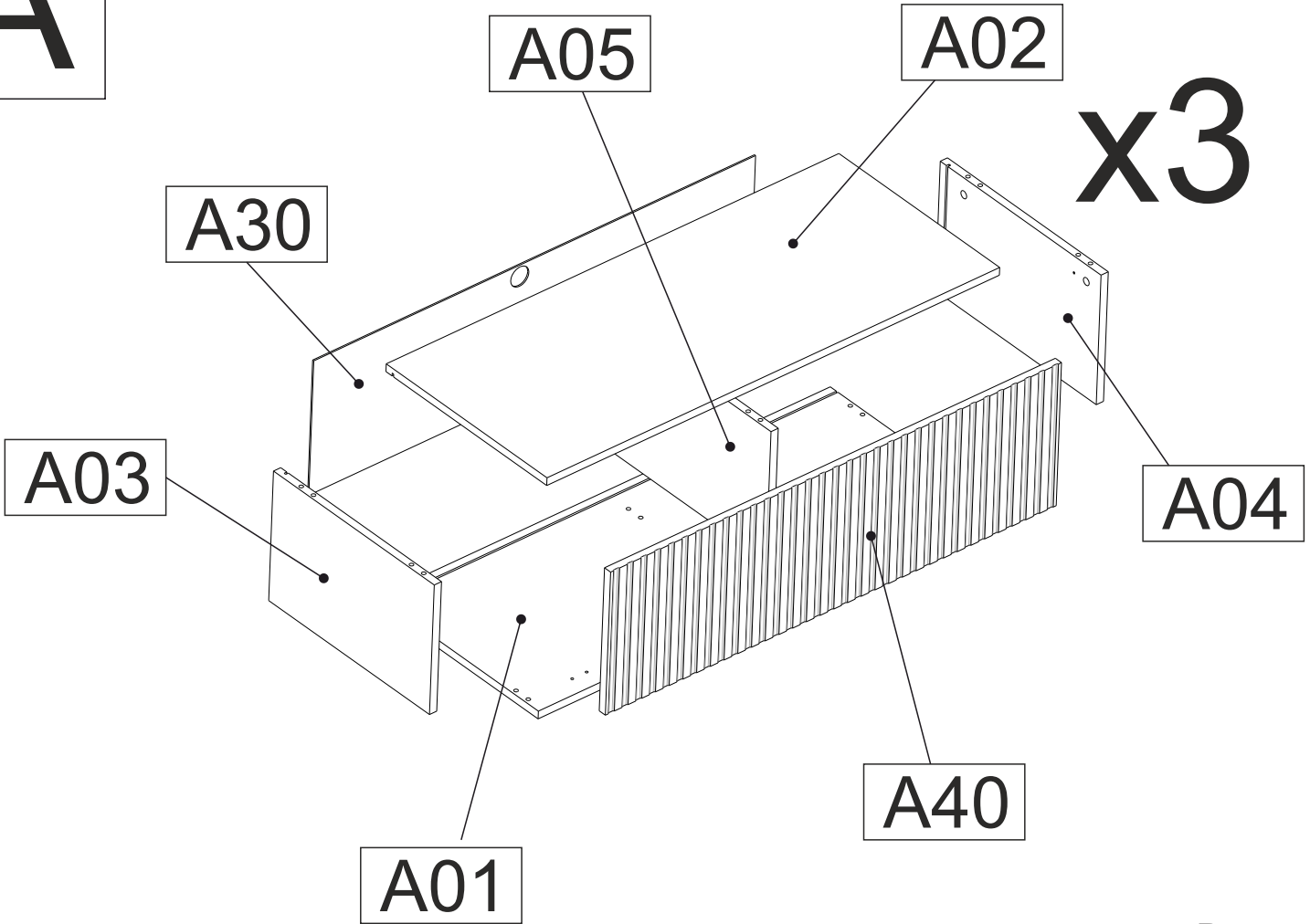

A	B_(mm)	C_(mm)	D_(mm)	E	F
A01	1000	420	16	3	2 4
A02	1000	420	16	3	2 4
A03	268	420	16	3	1 4
A04	268	420	16	3	1 4
A05	268	400	16	3	1 4
A30	976	278	3	3	1 4
A40	996	296	16	3	1 4

1

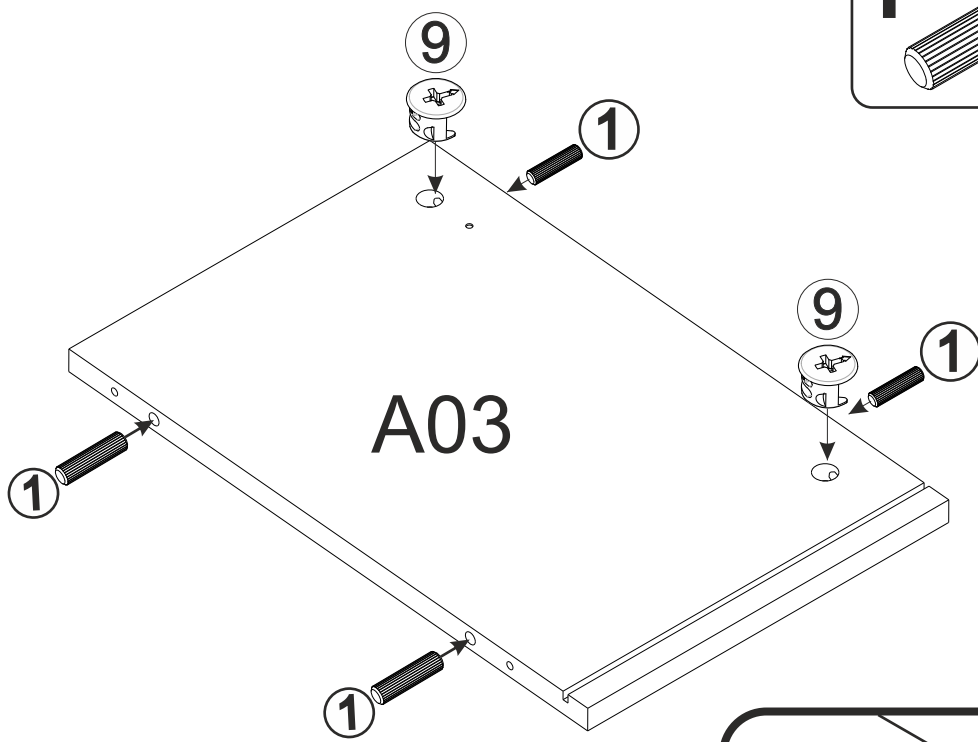

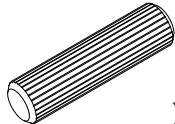
1  x4

9  $\varnothing 15$
x2

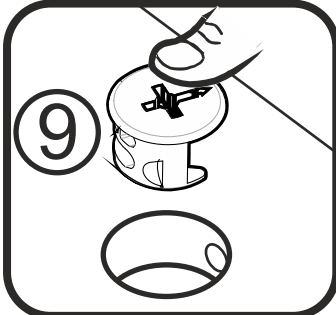
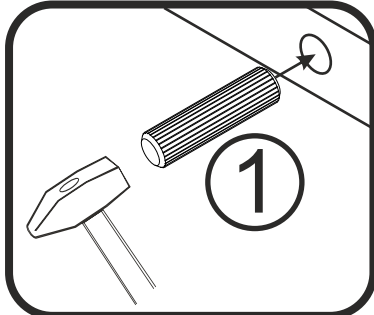

2

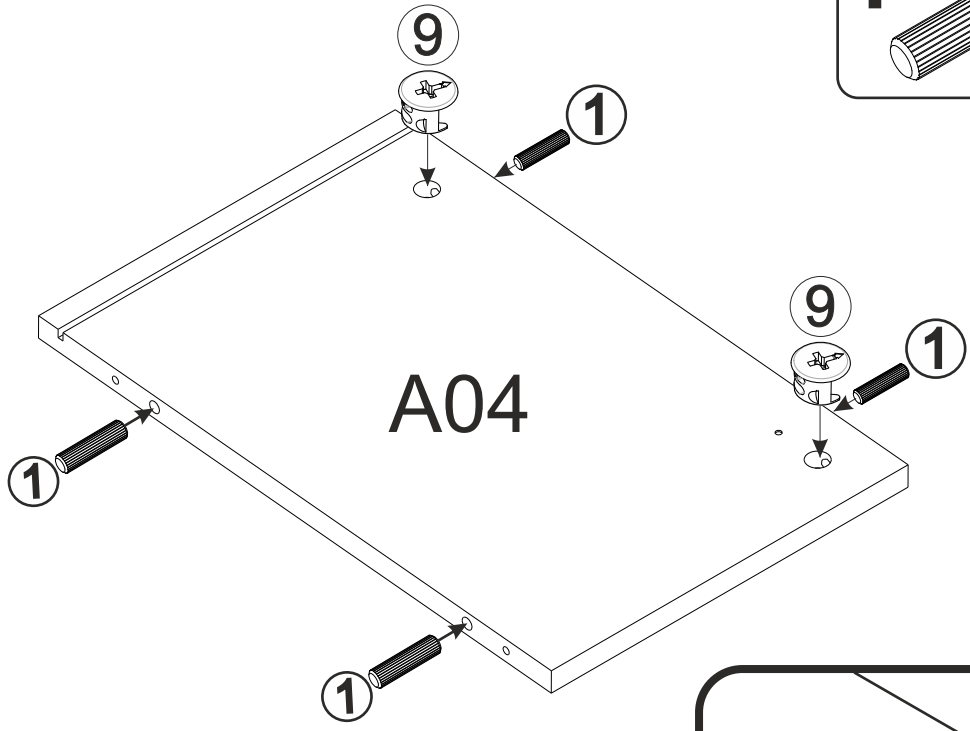

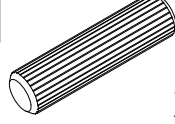
1  x4

9  $\varnothing 15$
x2

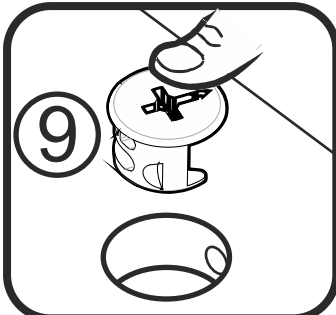
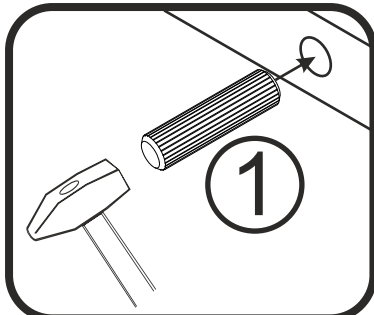

3

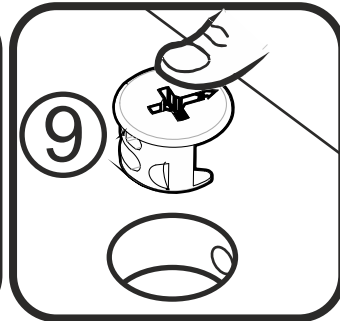
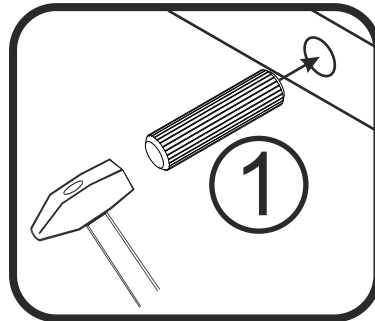
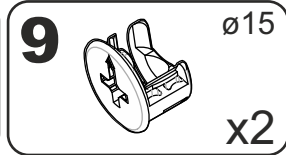
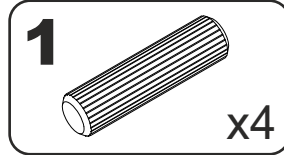
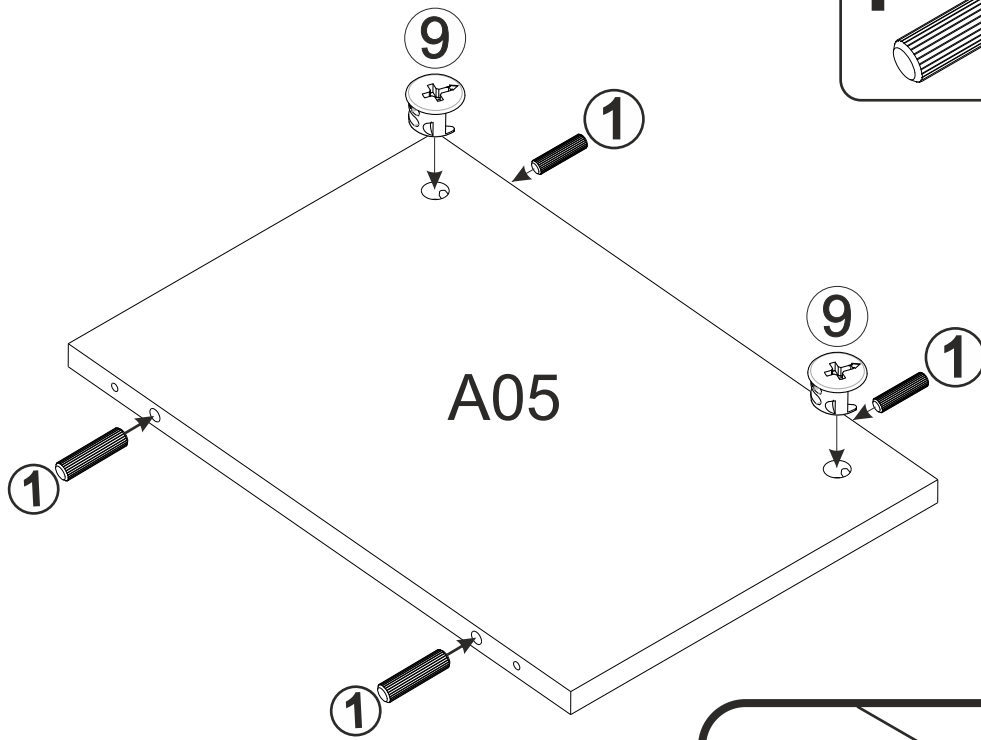

4

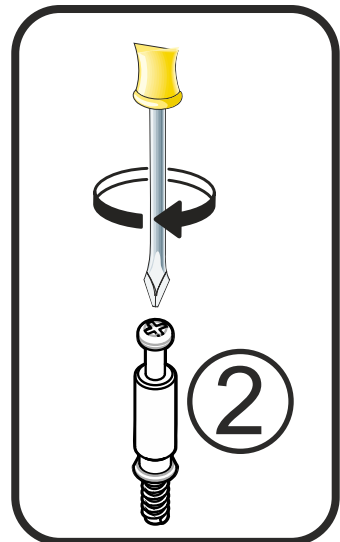
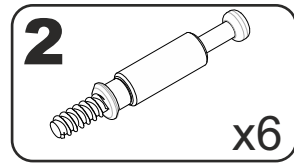
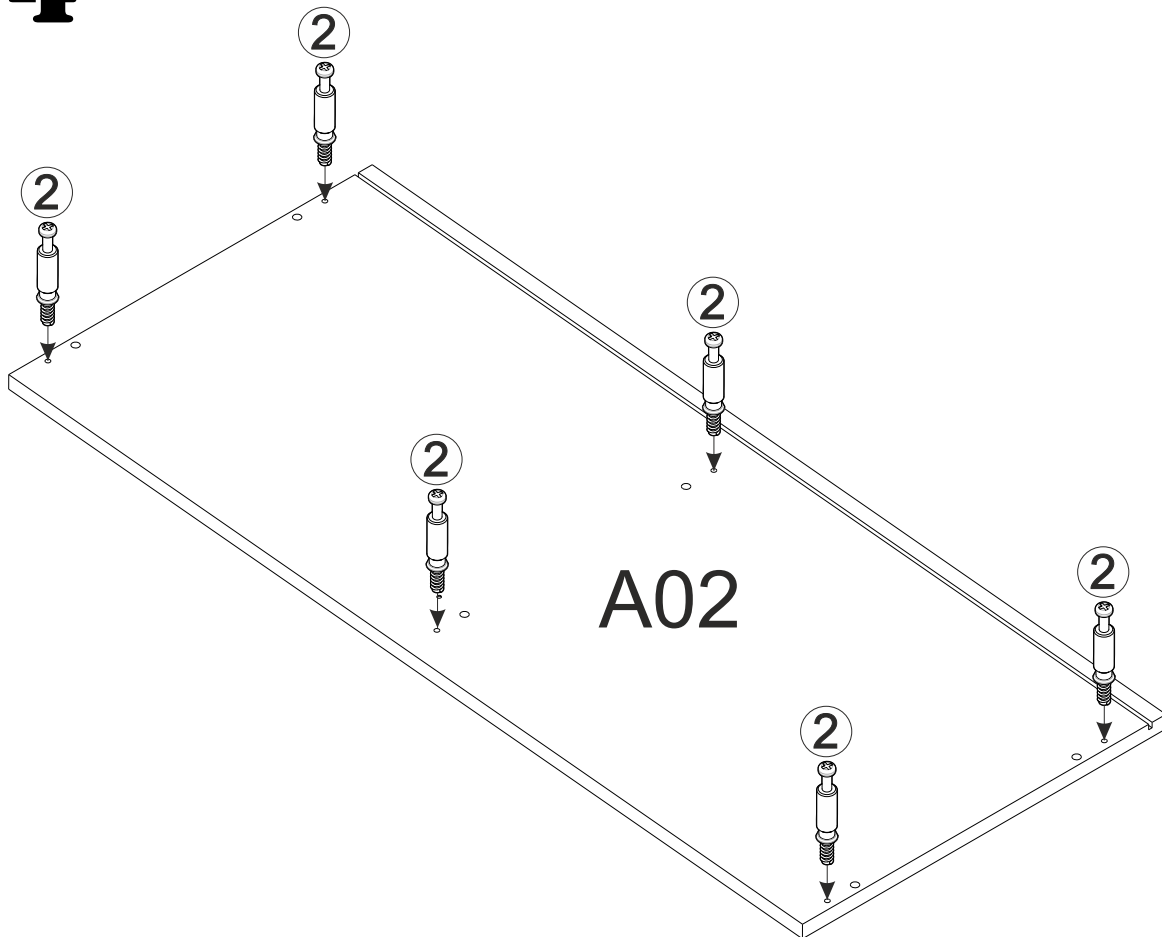

5

5

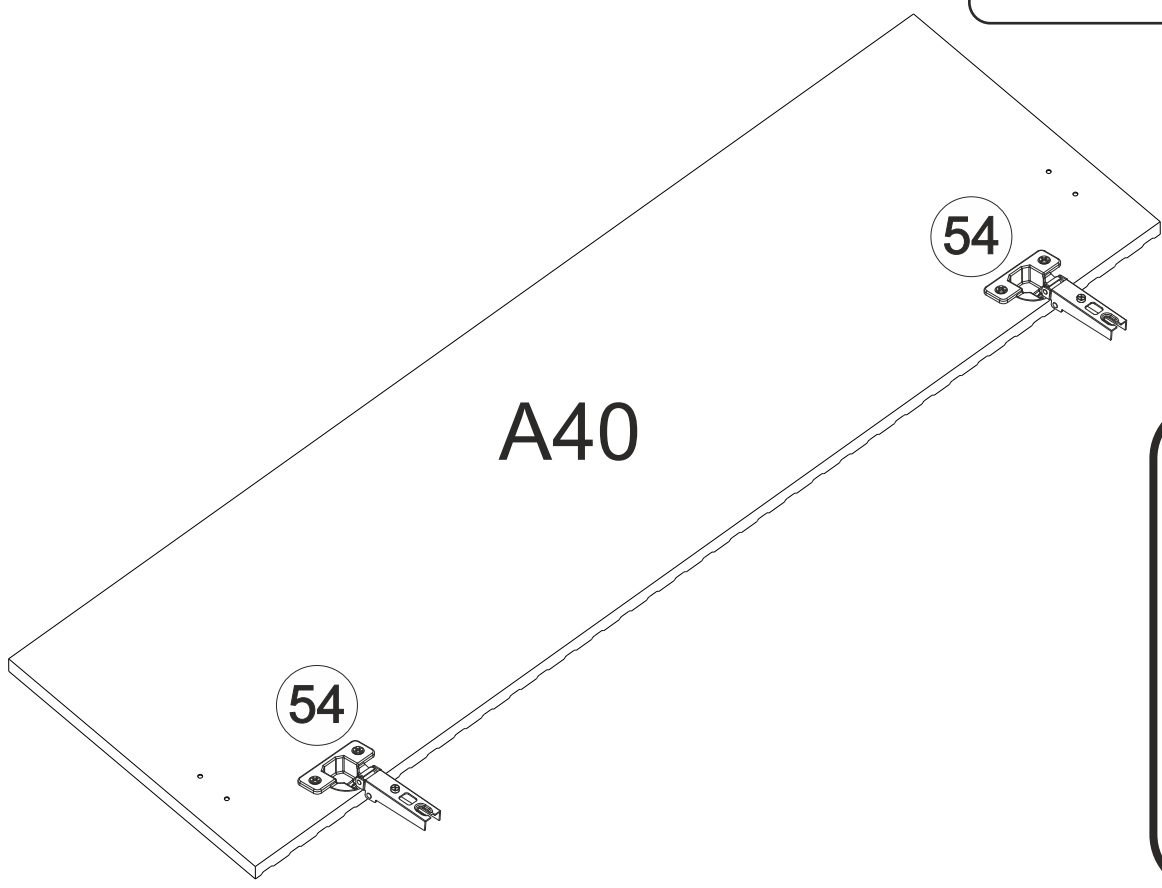

6 5x13
x4

54 $\varnothing 35$
x2

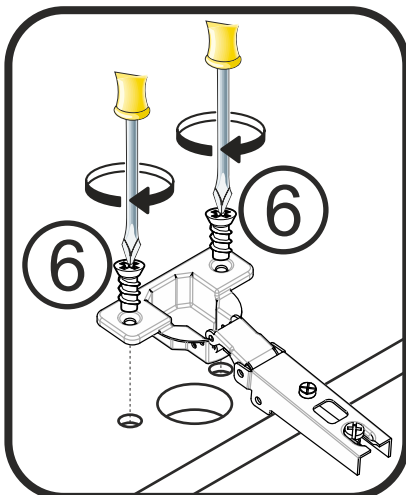
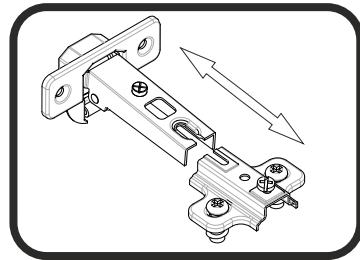

6

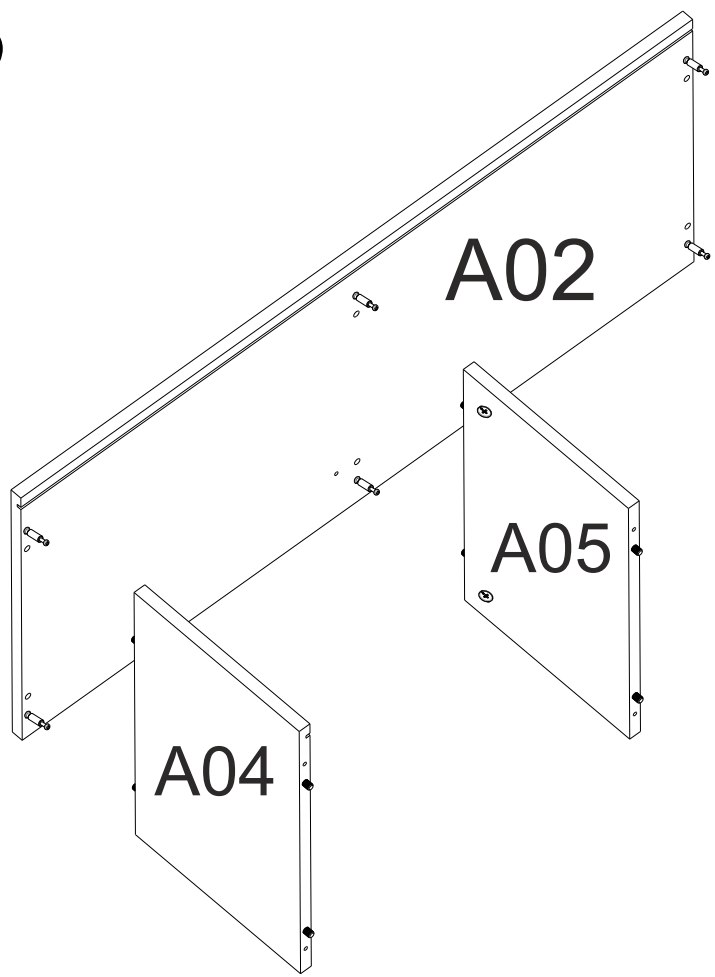

9A x6

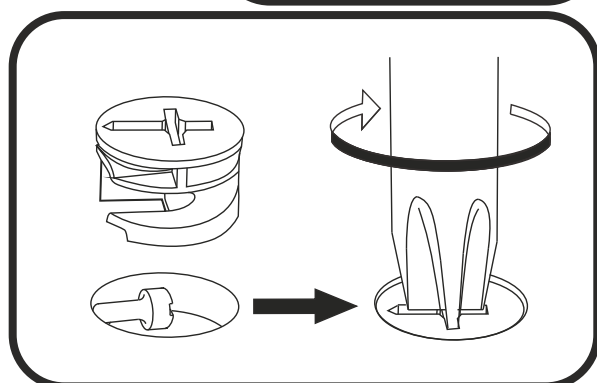
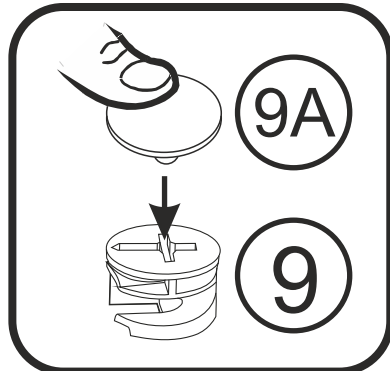

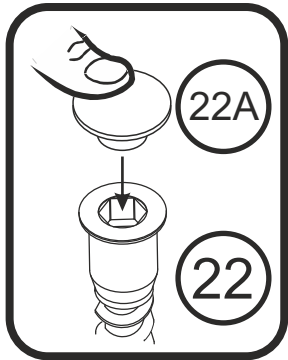
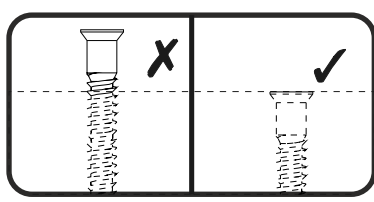
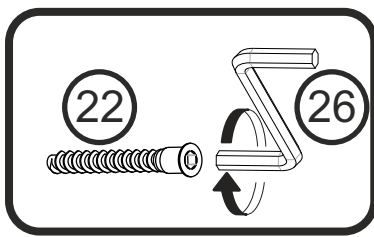
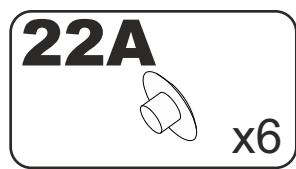
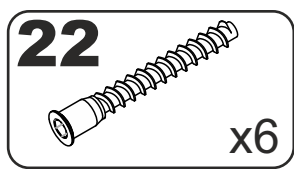
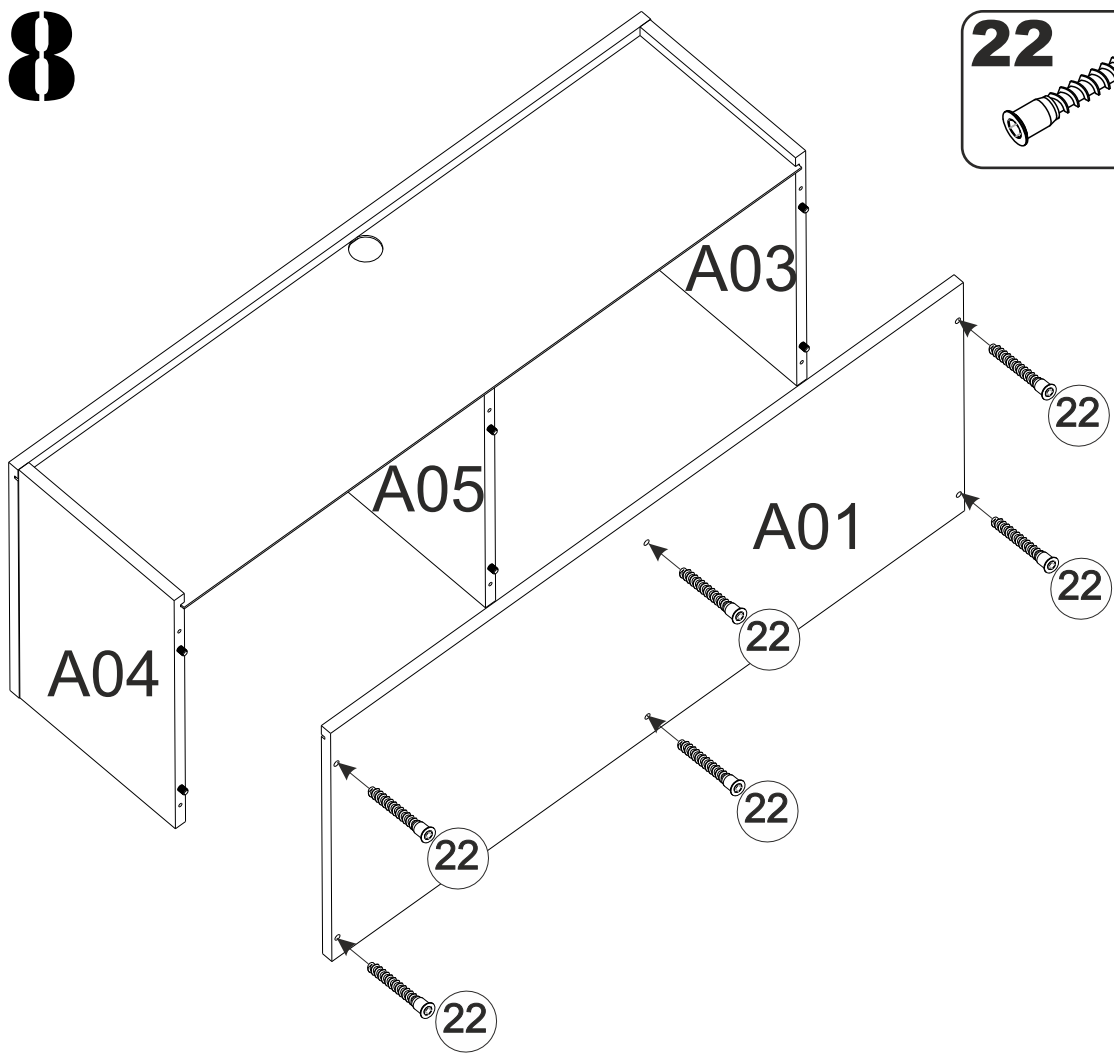
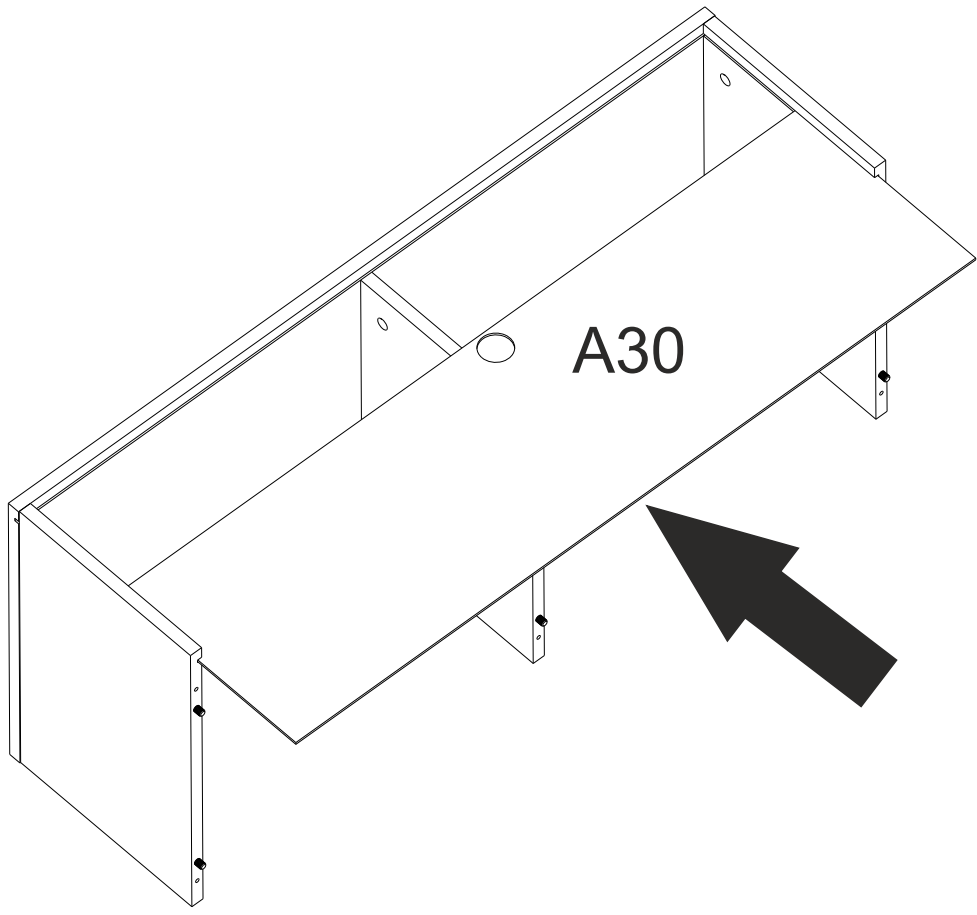

9

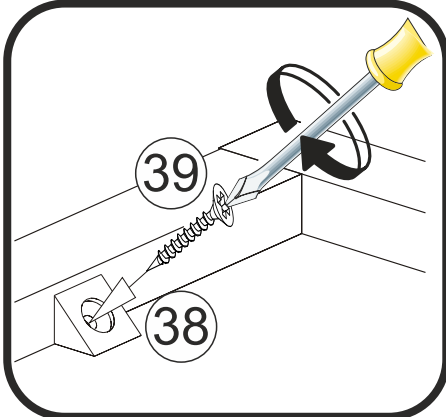
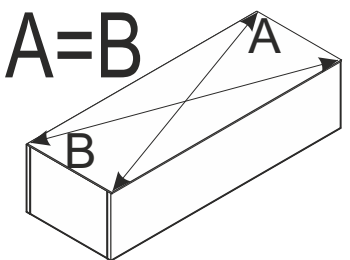
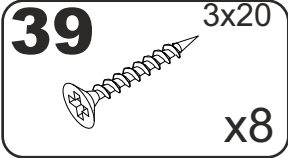
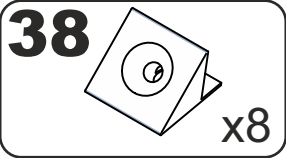
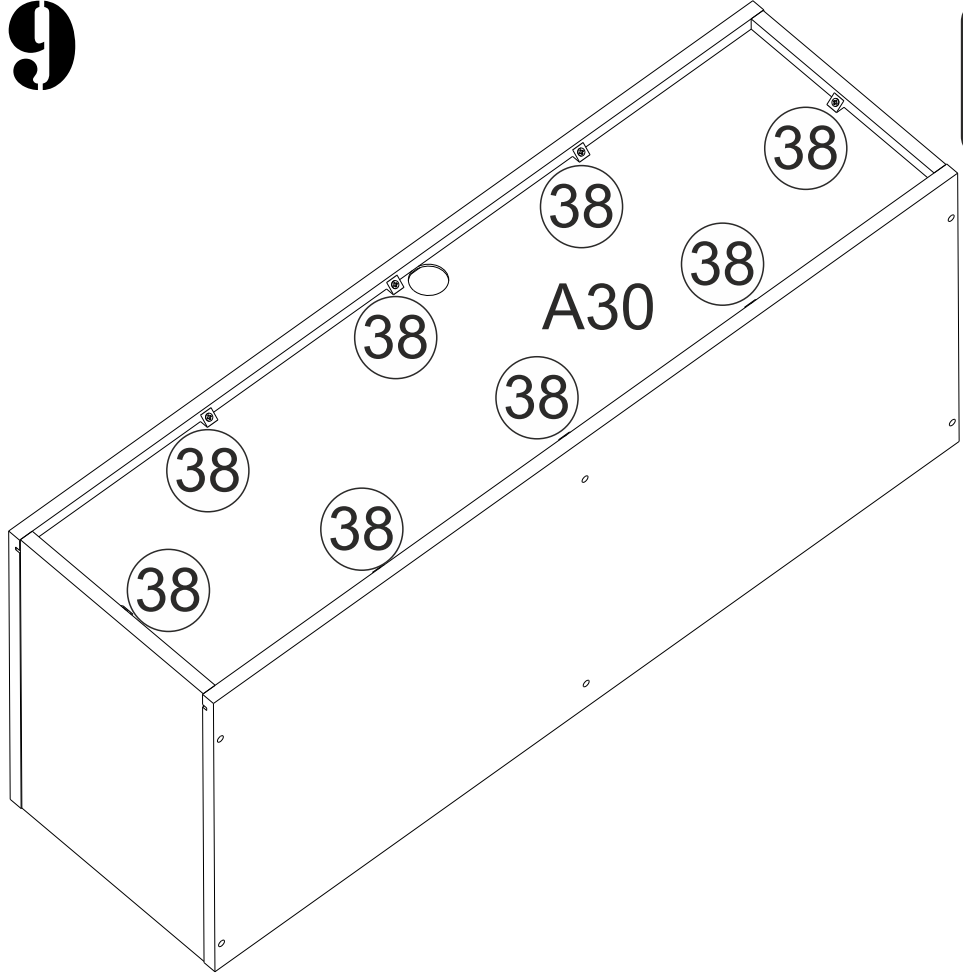

10

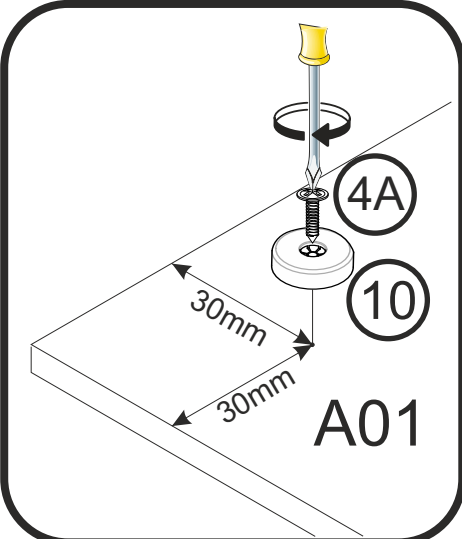
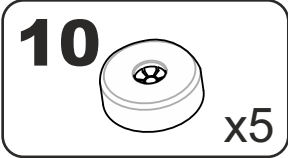
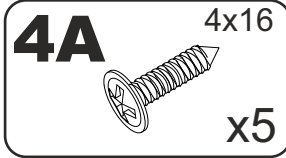
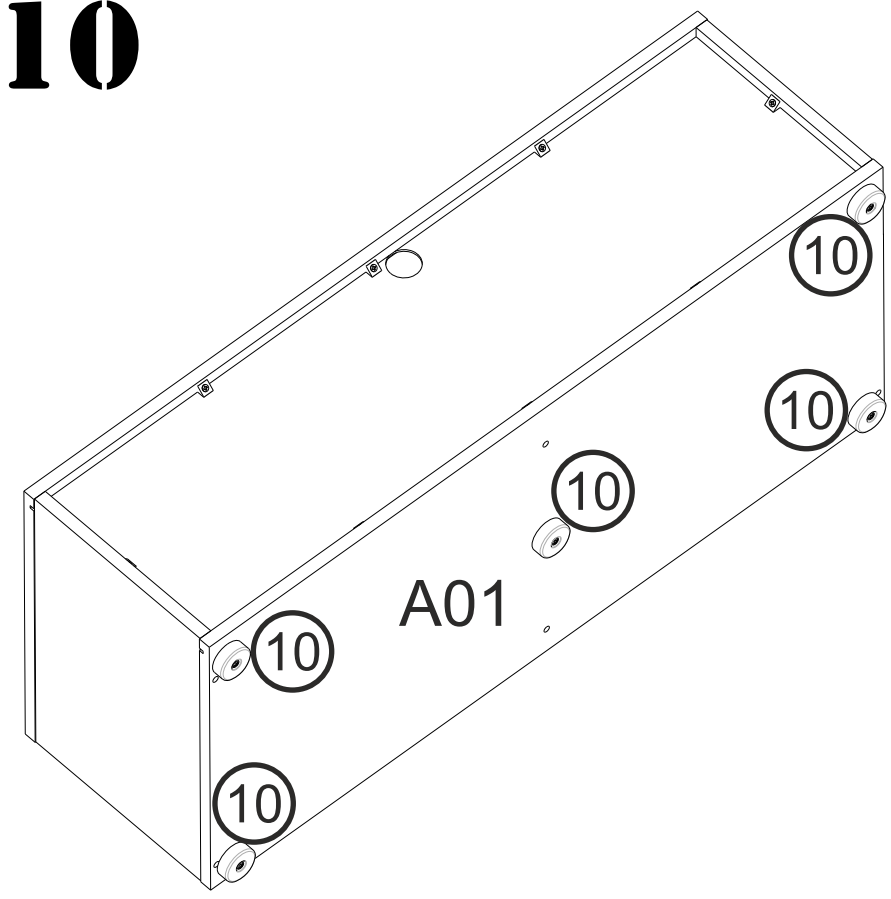

11

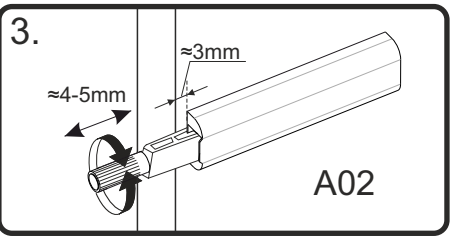
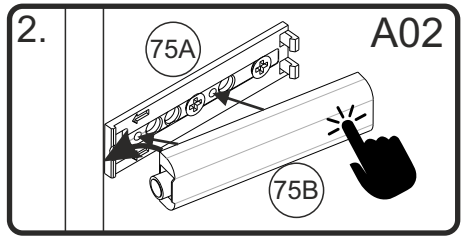
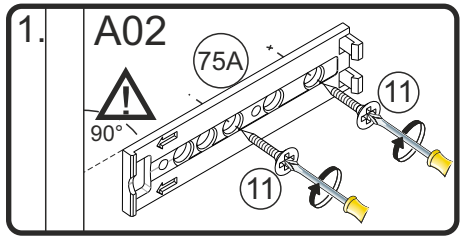
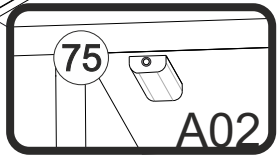
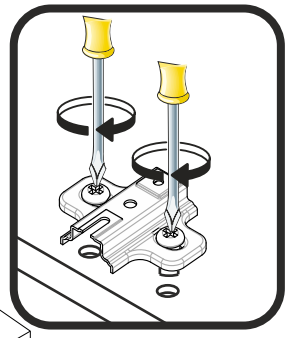
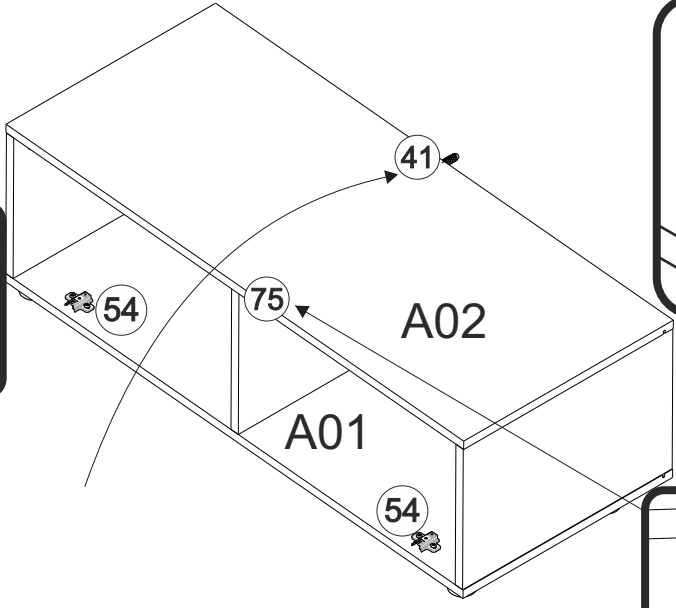
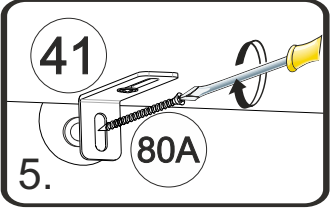
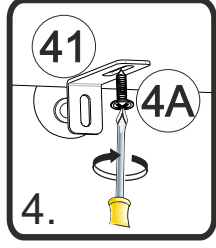
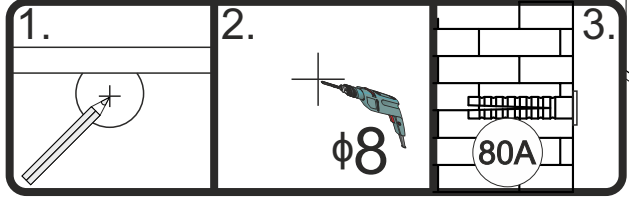
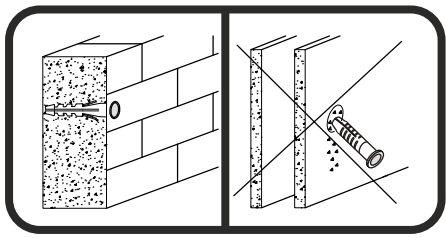
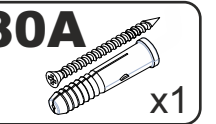
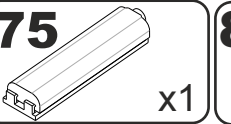
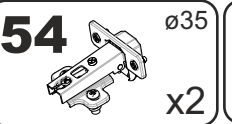
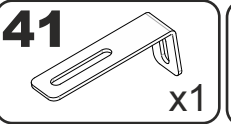
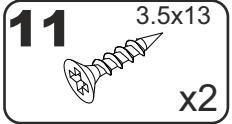
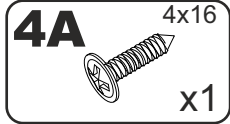

12

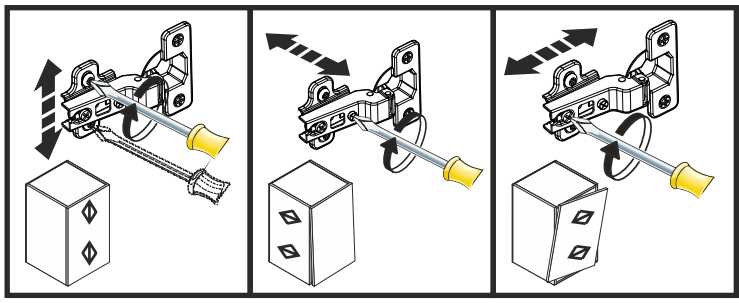
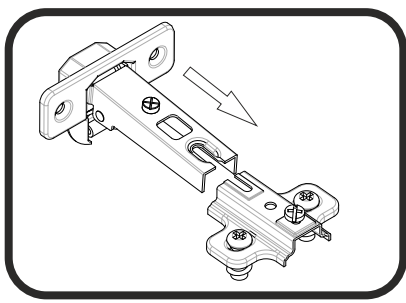
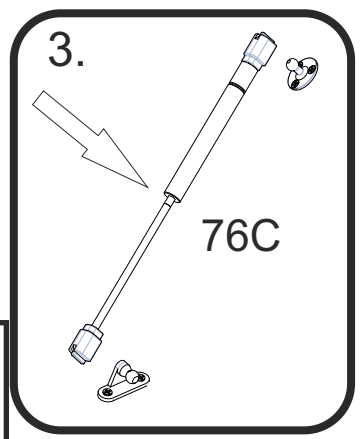
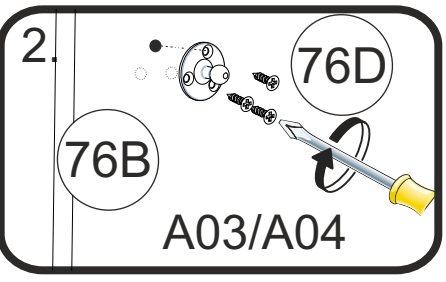
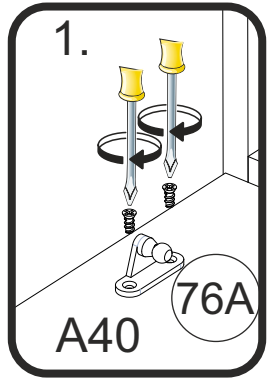
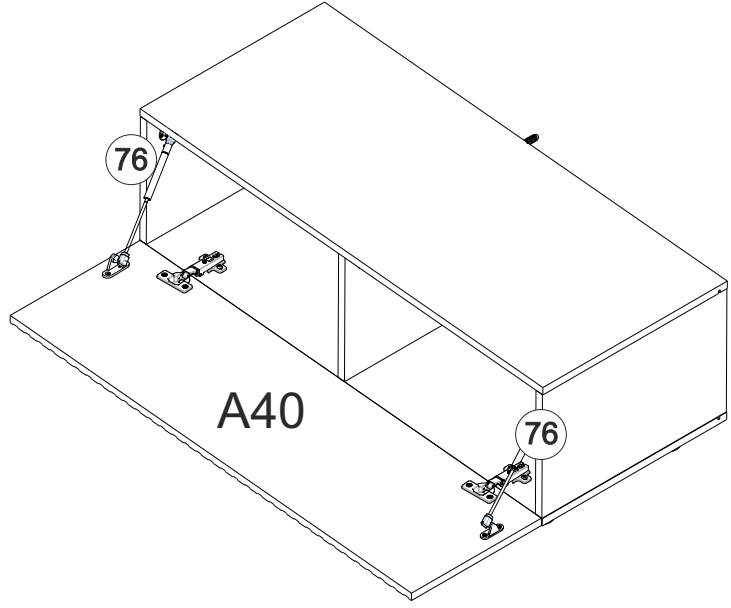
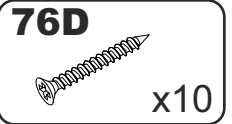
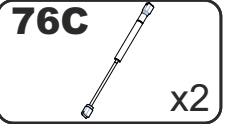
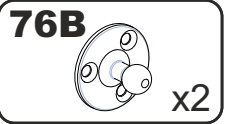
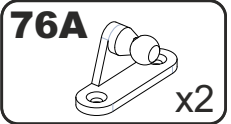
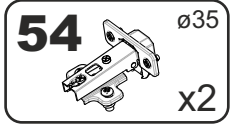

A

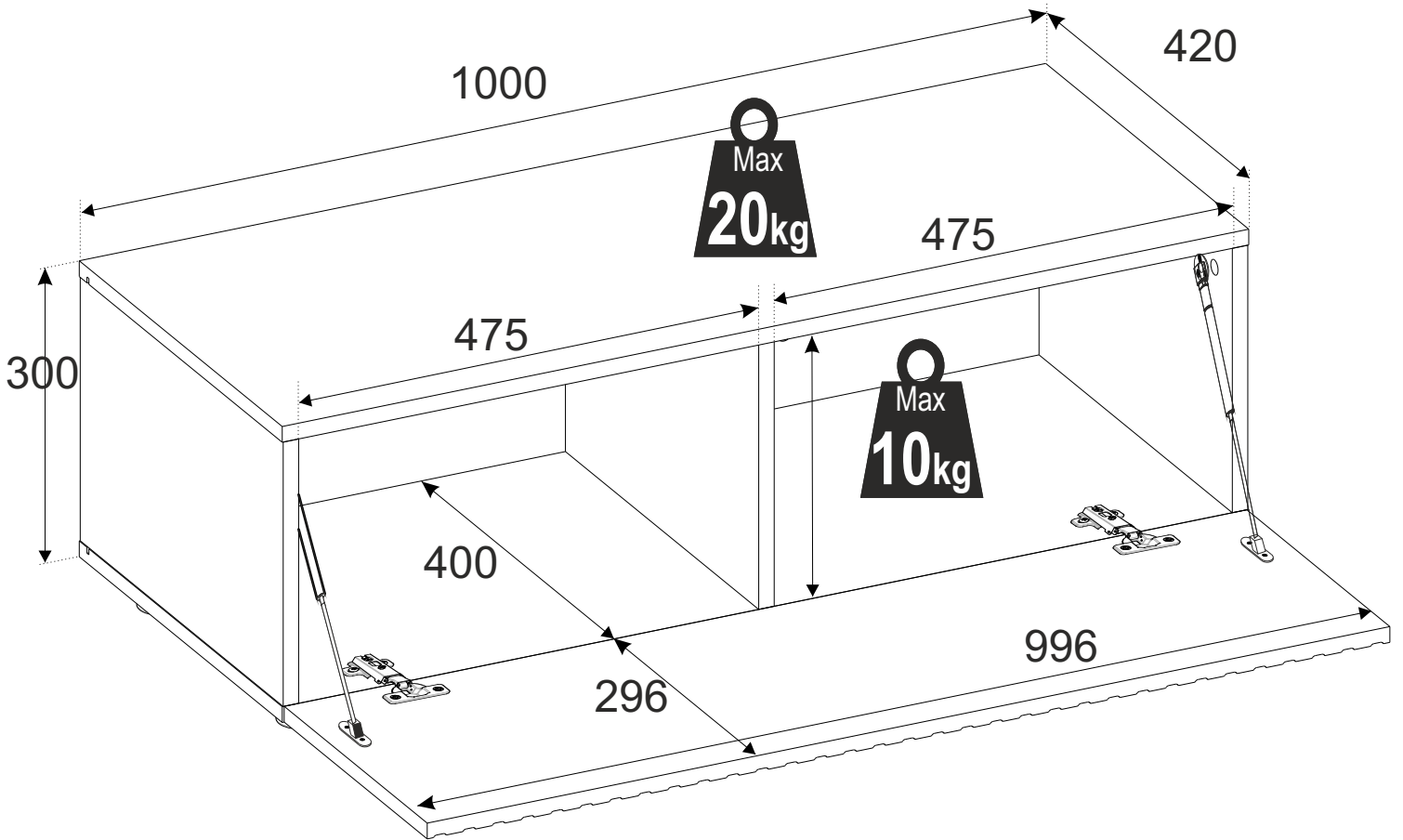
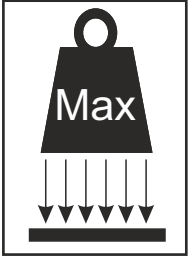

B

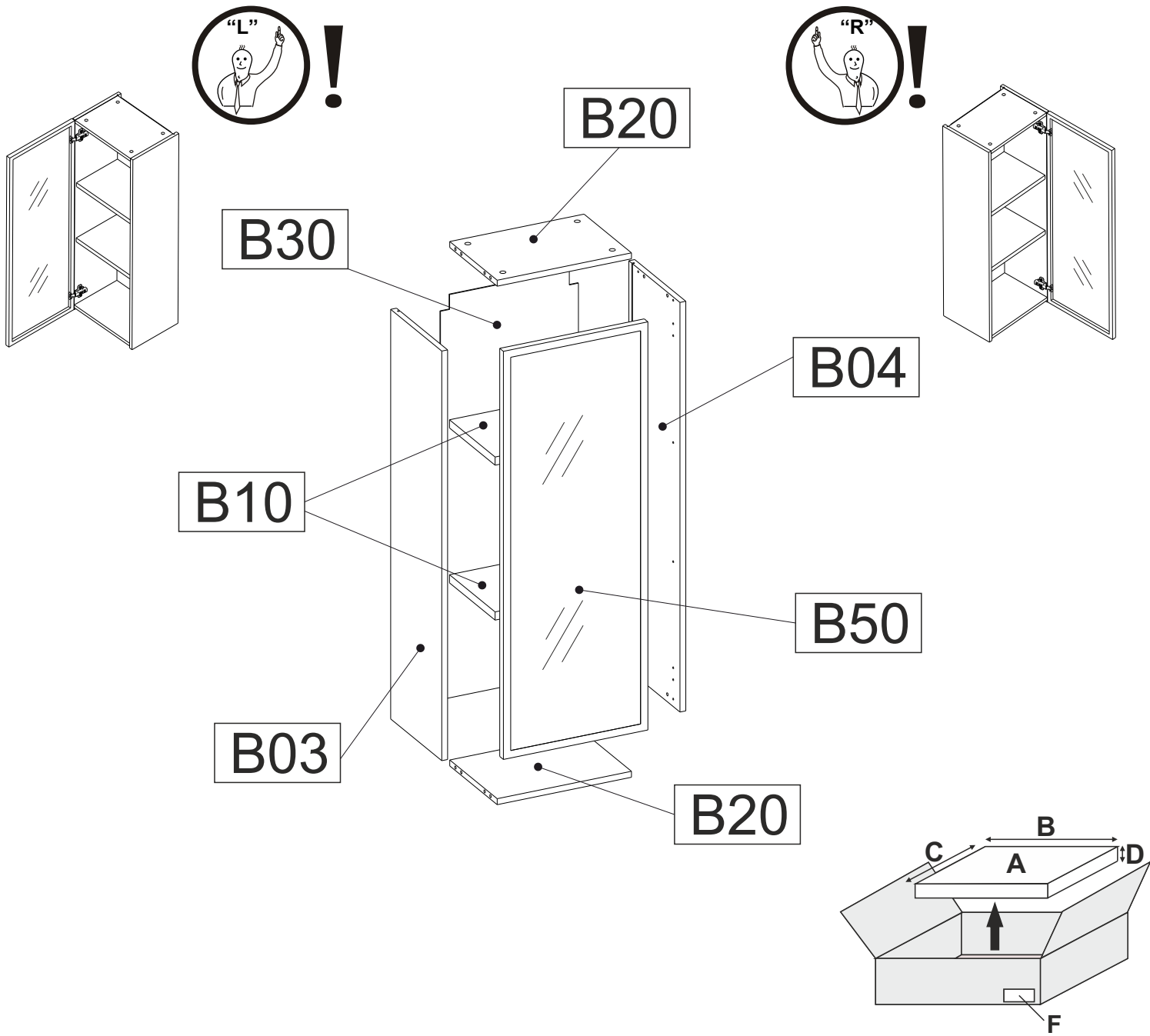

A	B_(mm)	C_(mm)	D_(mm)	E	F
B03	1100	280	16	1	4 4
B04	1100	280	16	1	4 4
B10	368	250	22	2	3 4
B20	368	260	16	2	4 4
B30	1083	378	3	1	3 4
B50	1096	396	20	1	3 4

1

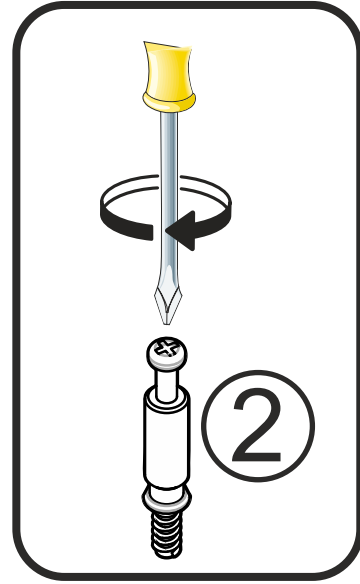
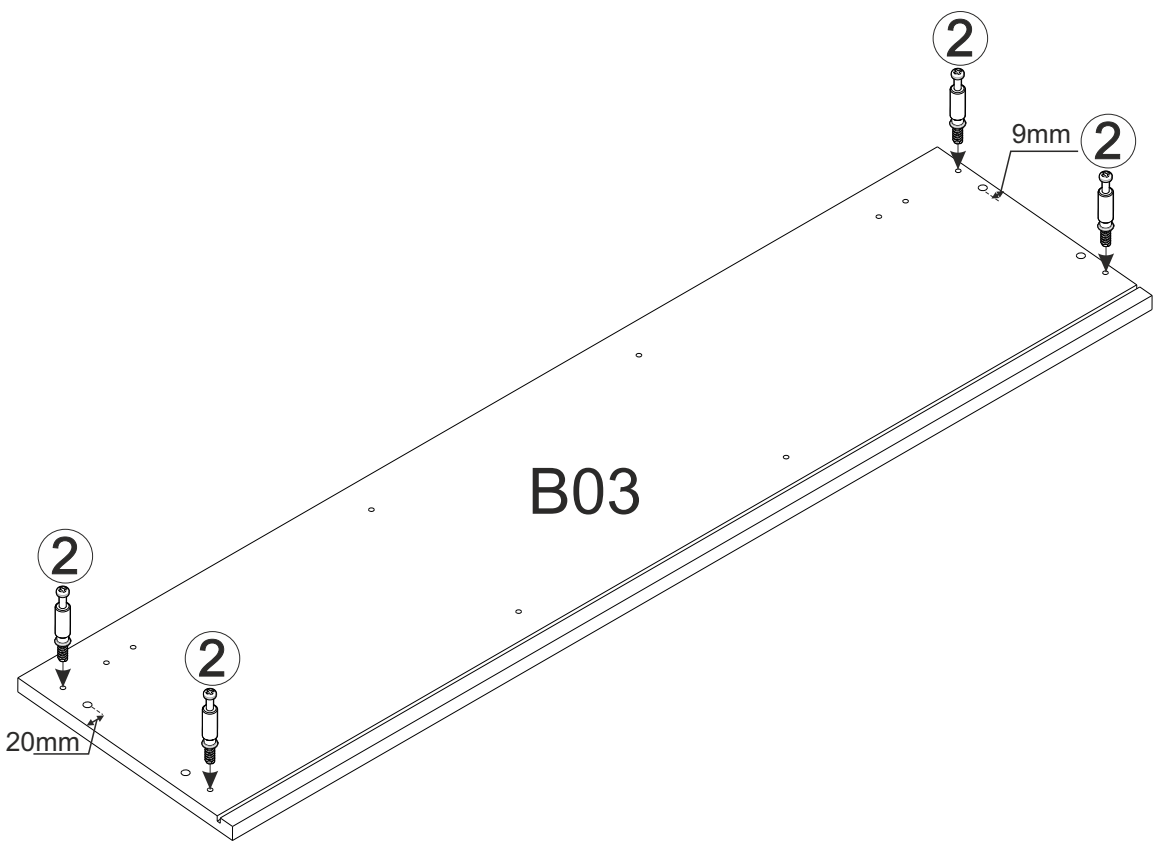
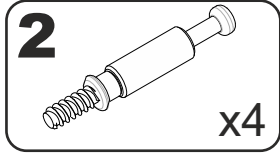

2

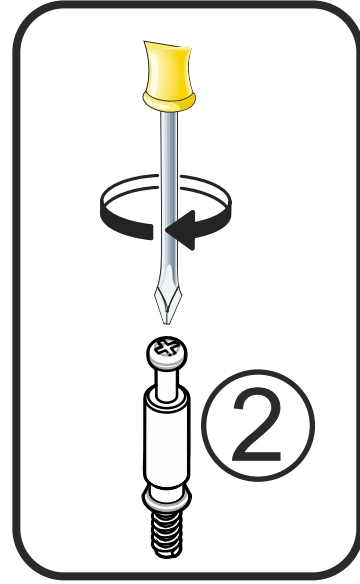
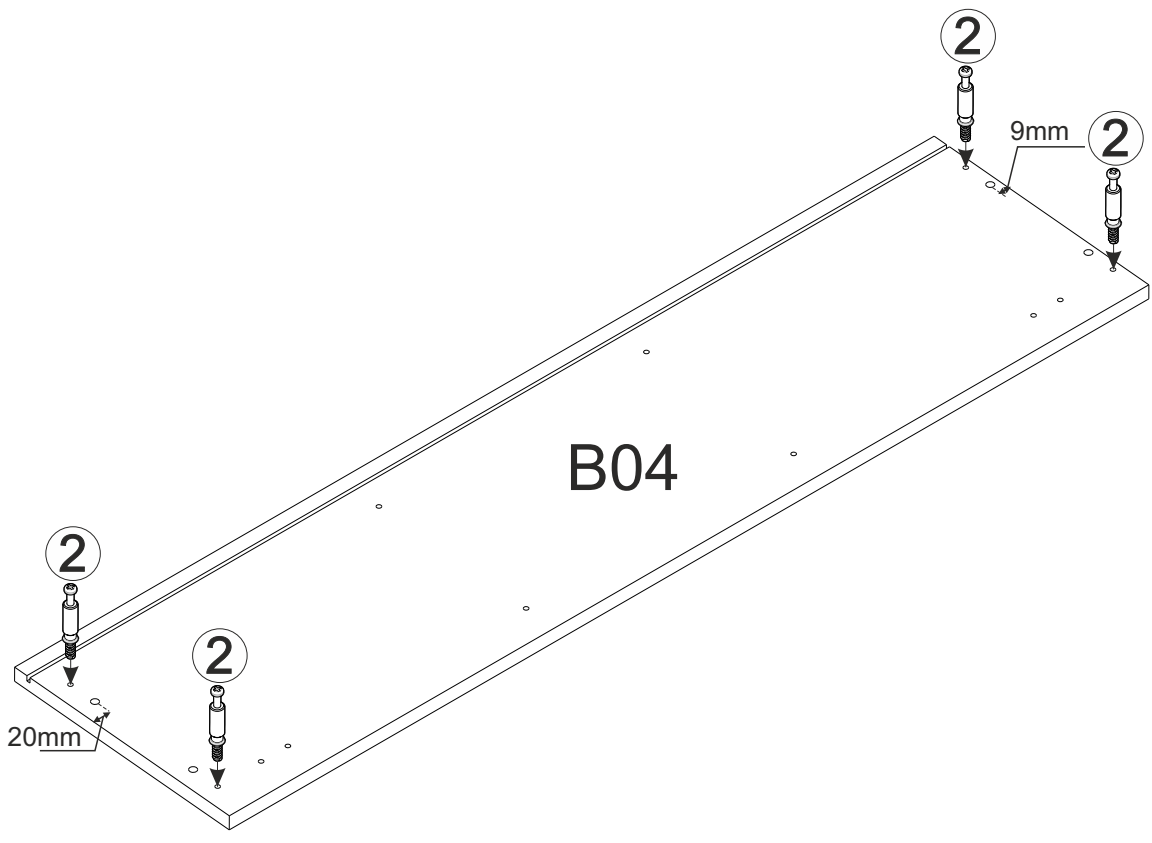
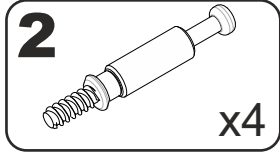

3

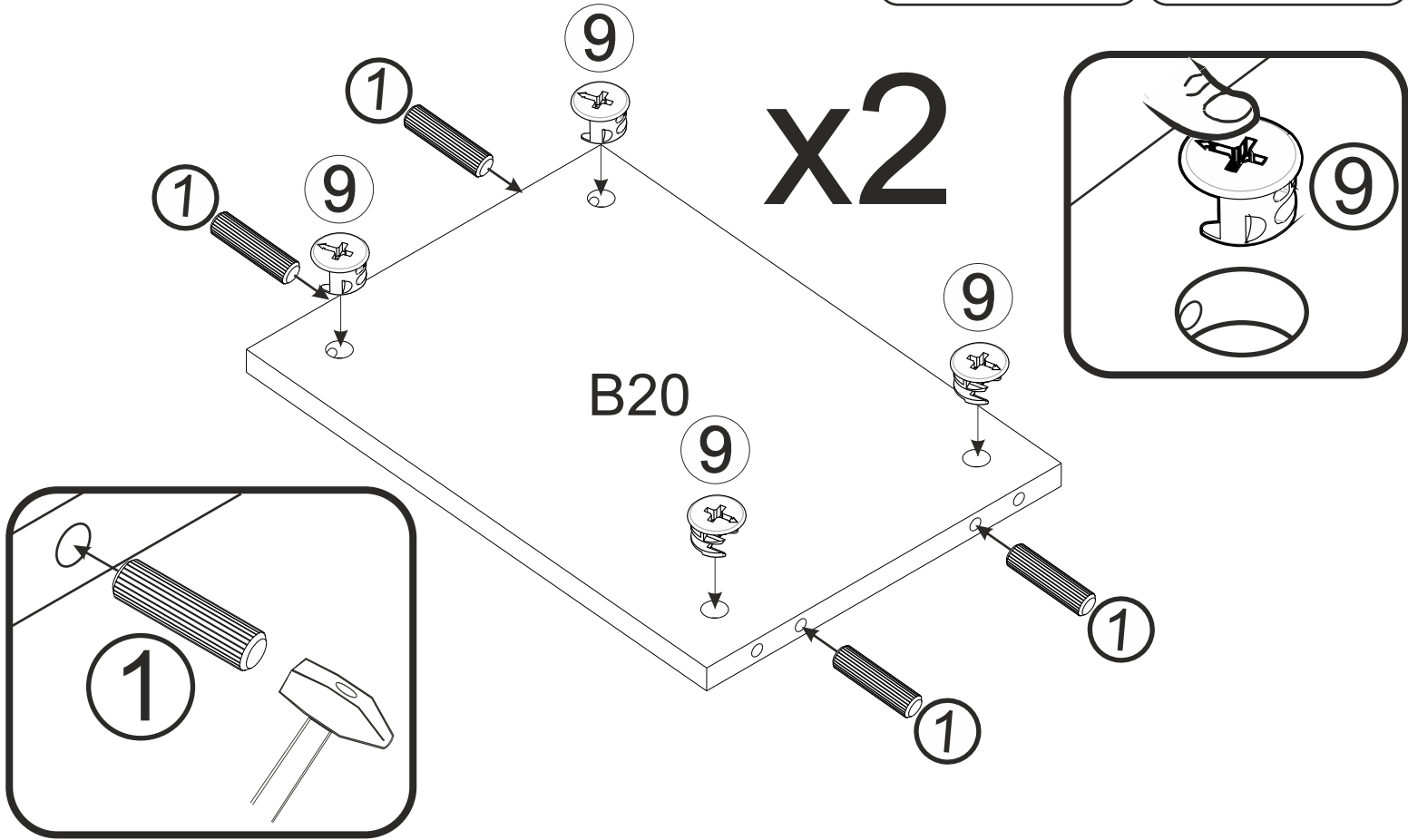
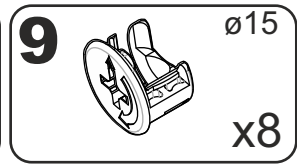
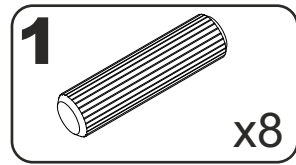

4

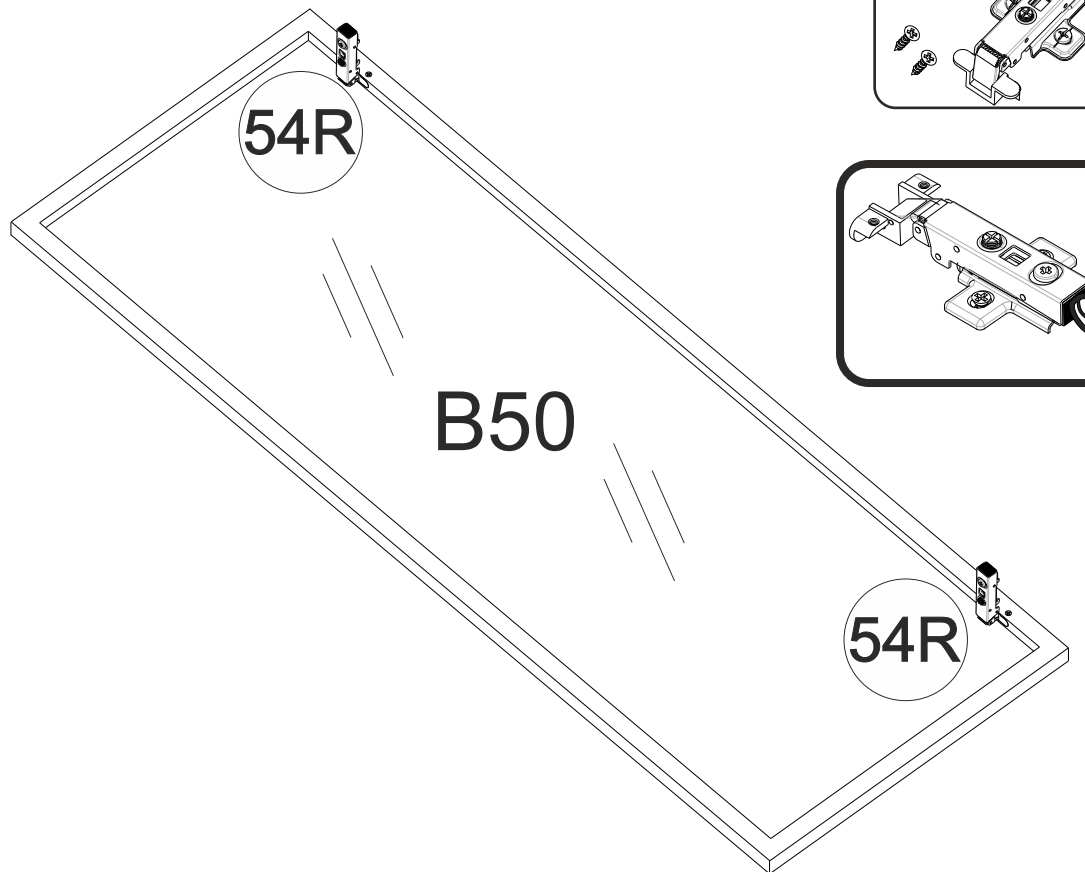
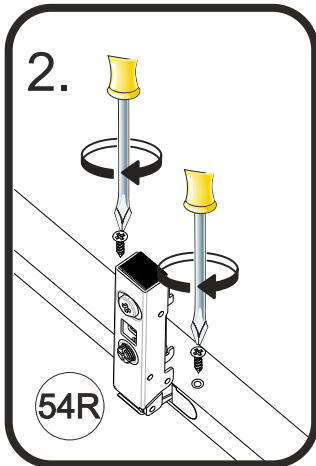
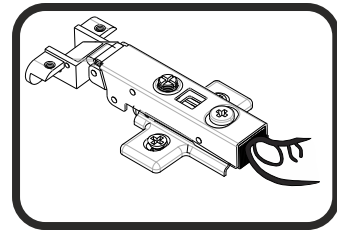
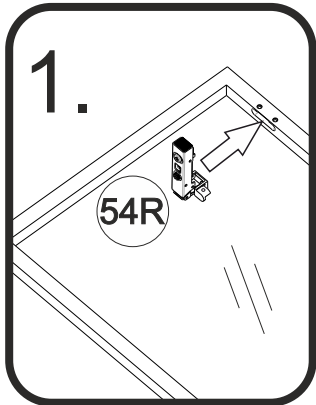
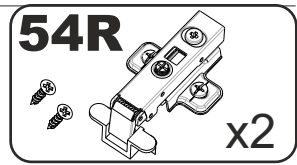

5

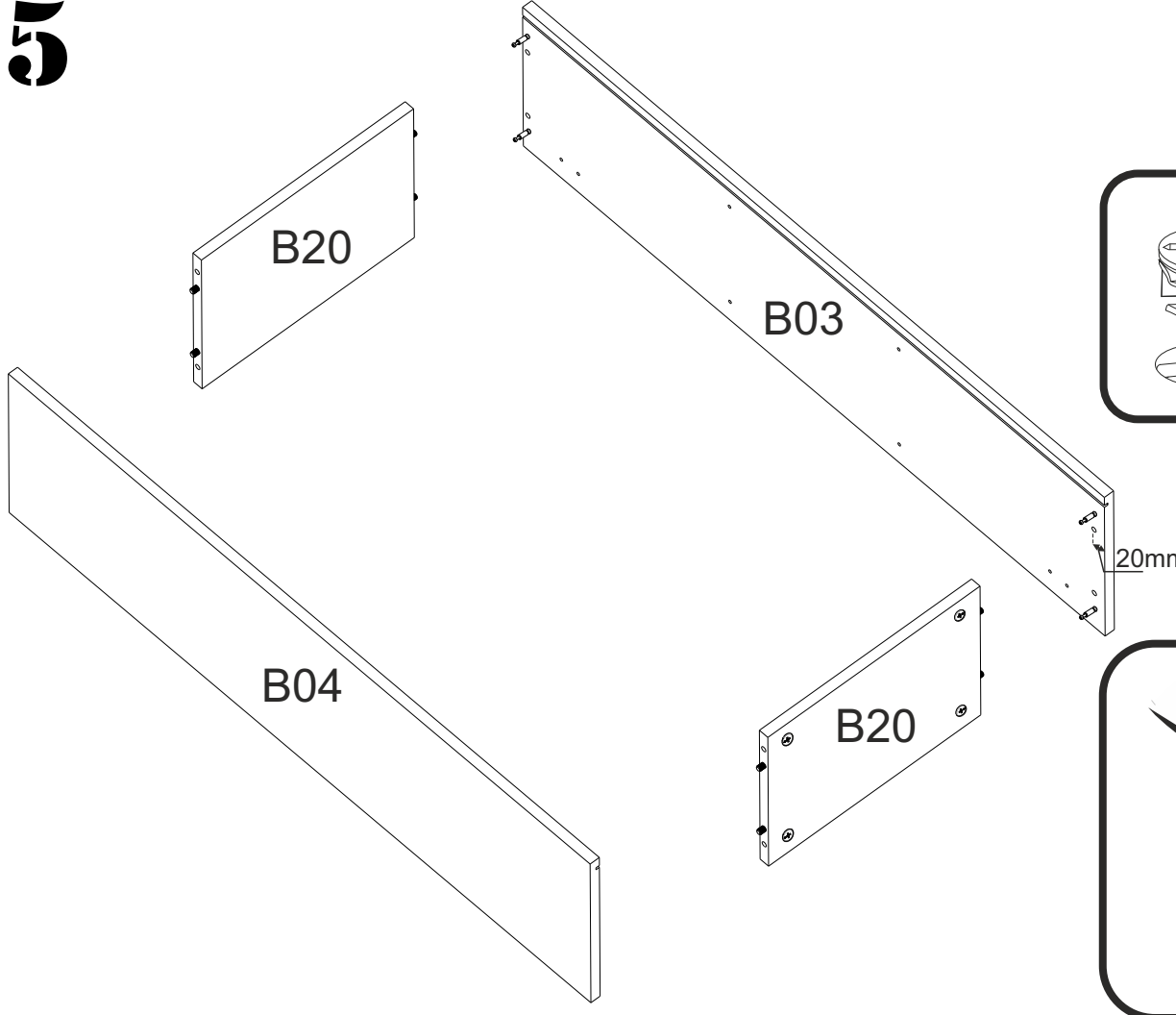

9A  x8

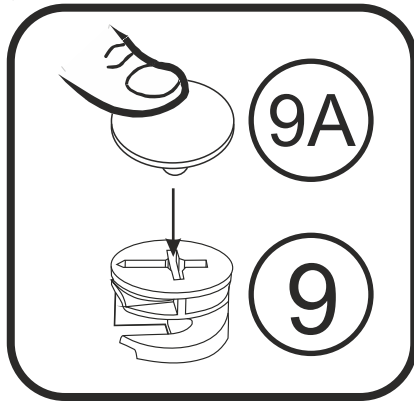
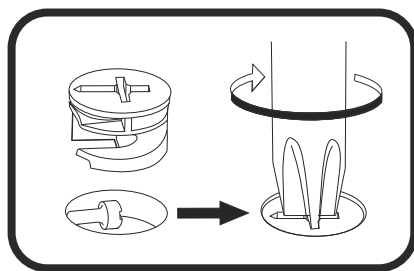

6

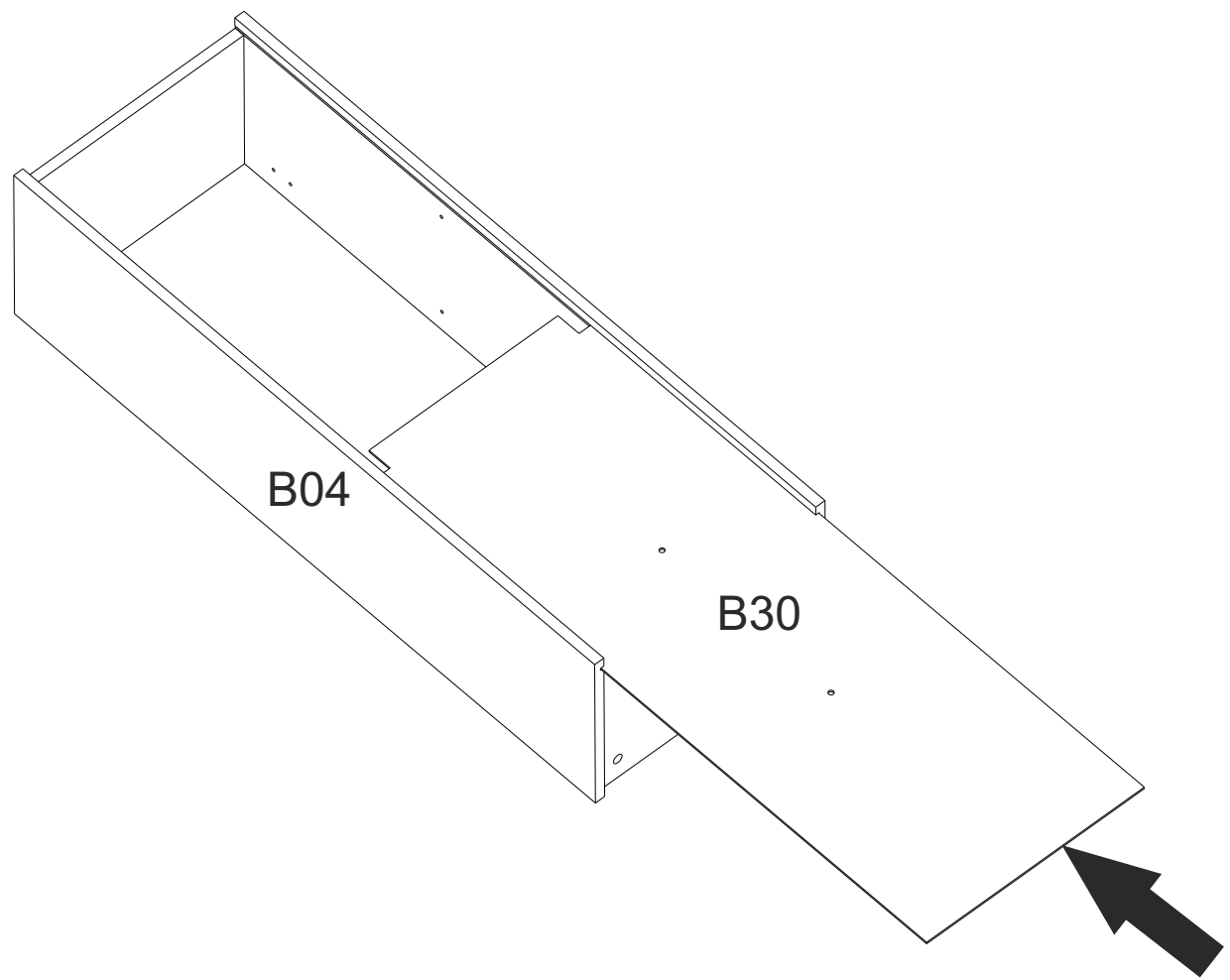

7

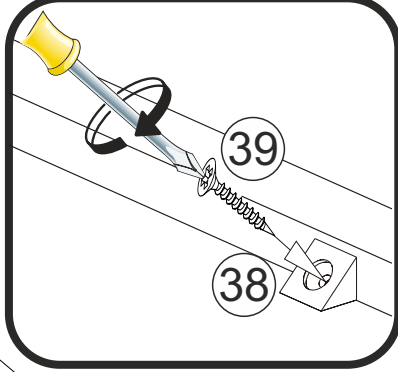
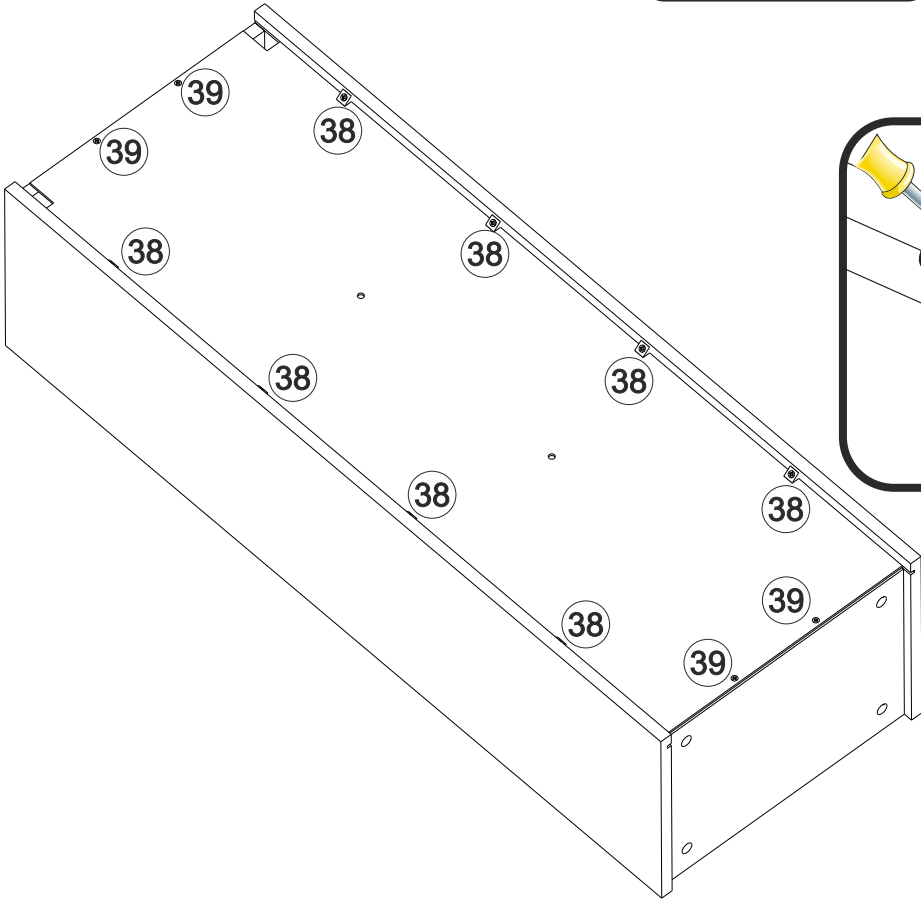
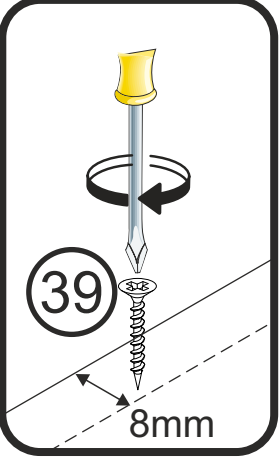
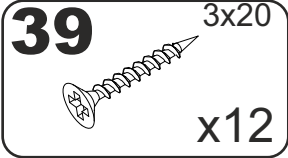
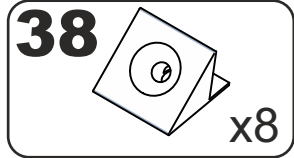

8

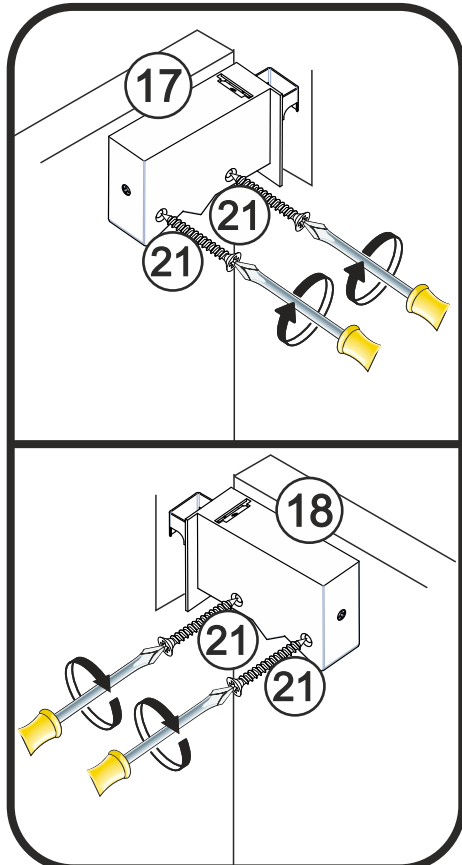
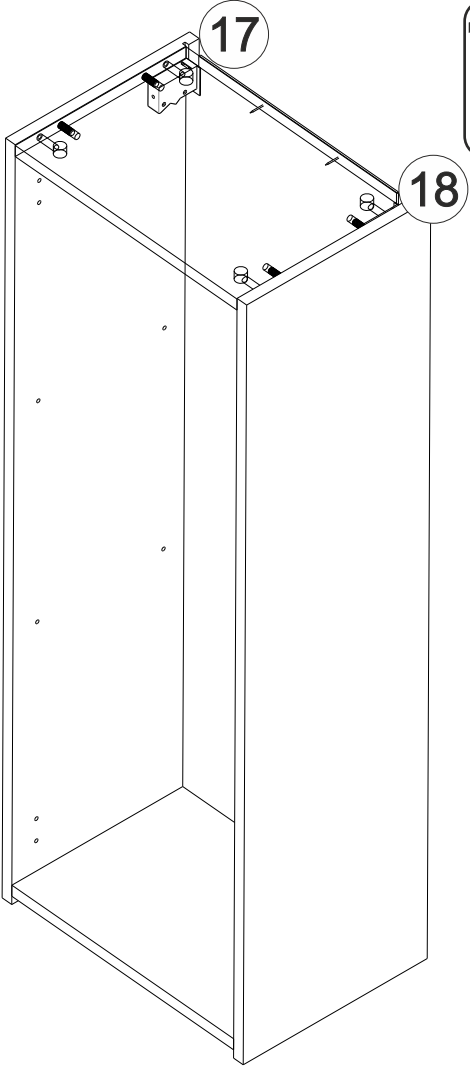
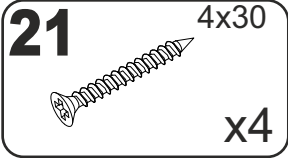
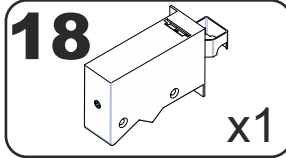
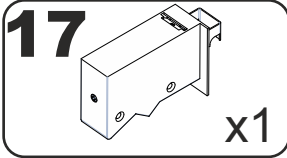

9

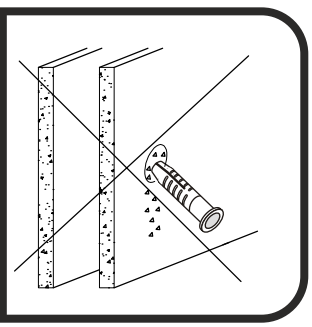
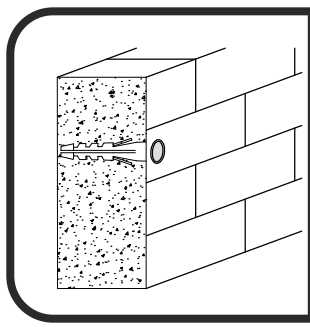
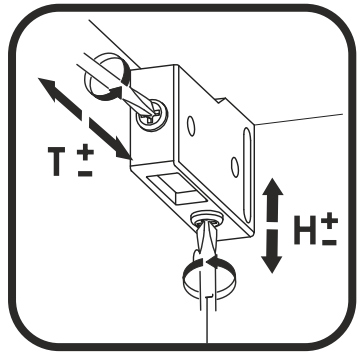
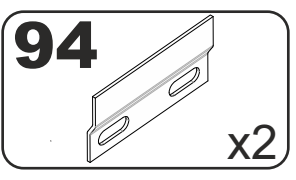
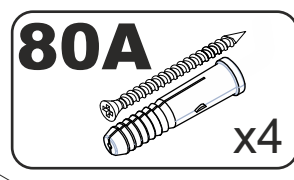
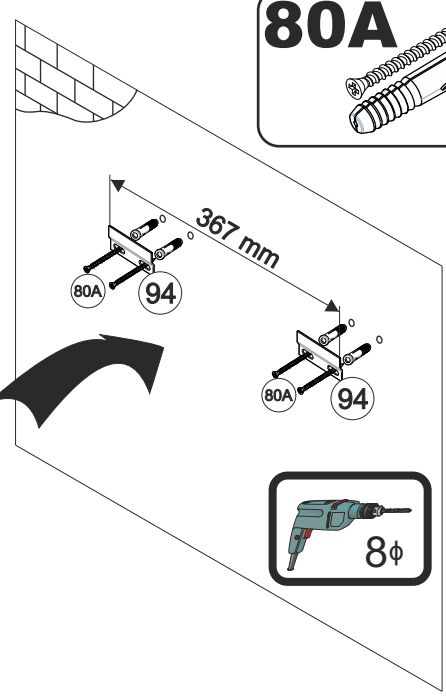
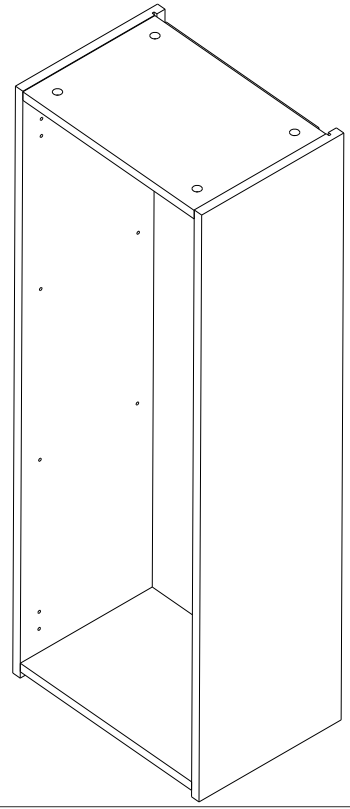
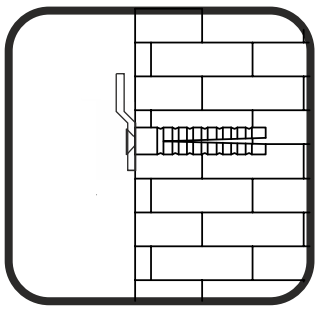
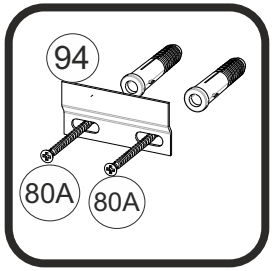

10

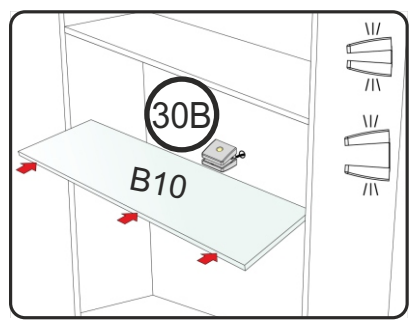
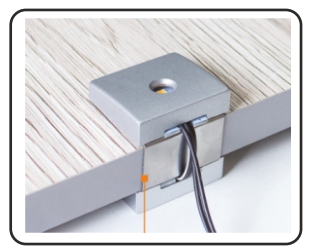
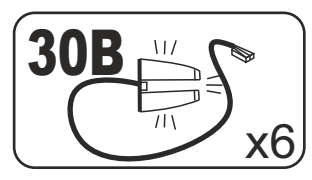
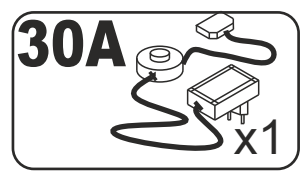
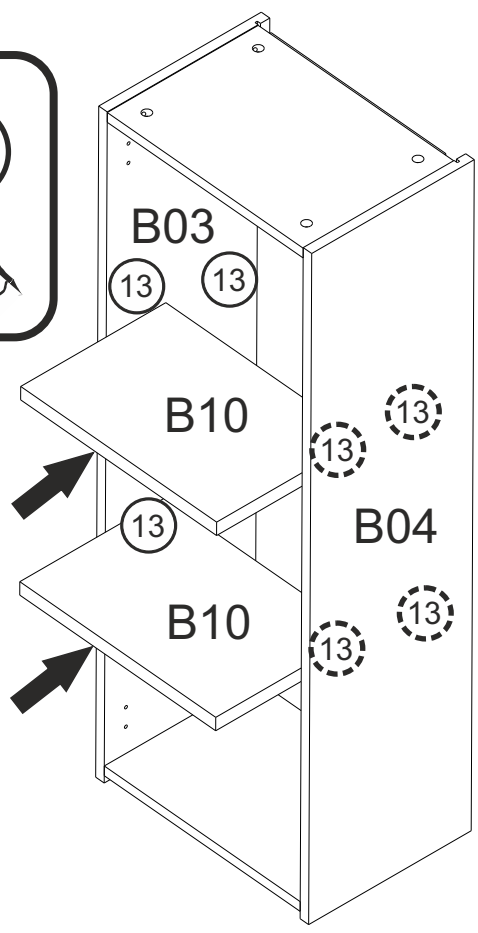
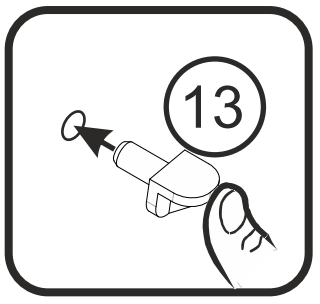

11

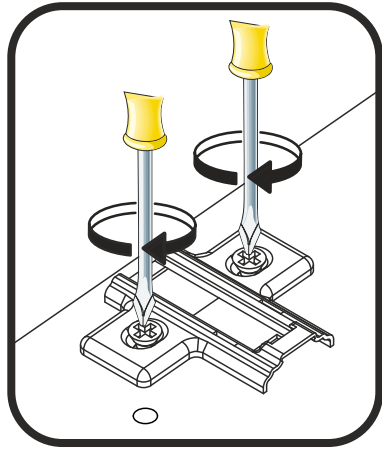
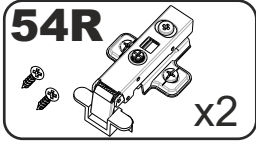
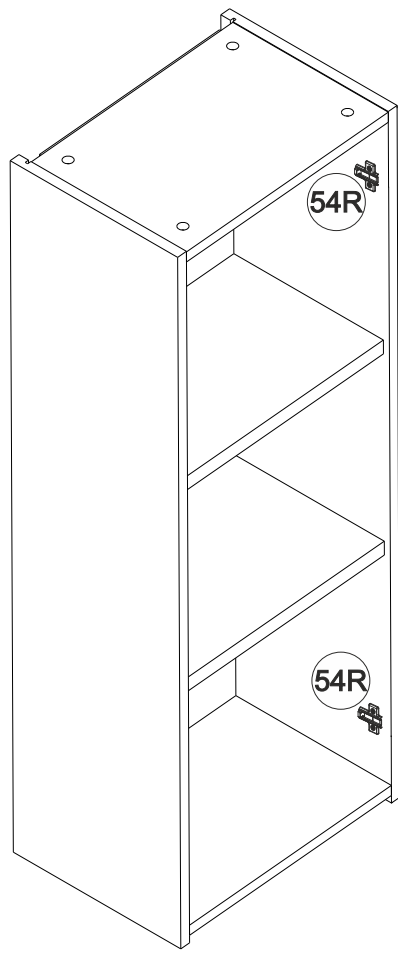
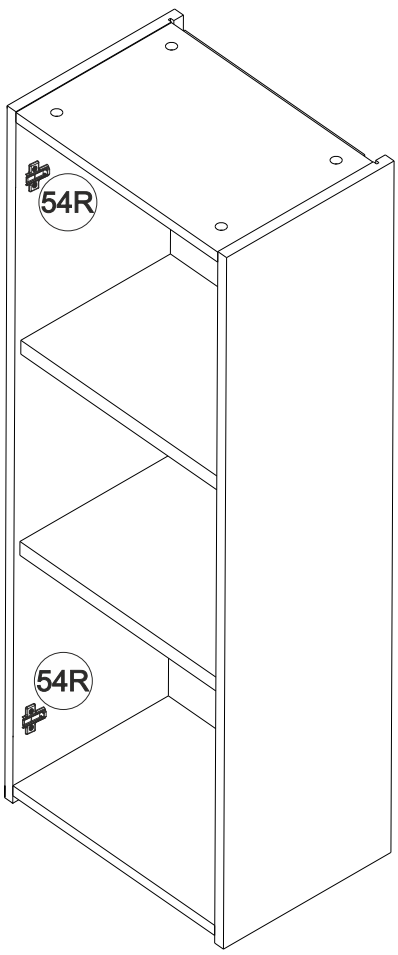

12

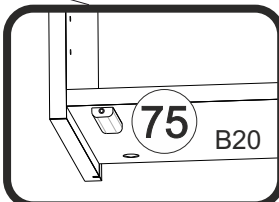
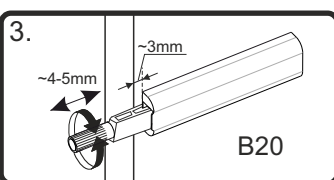
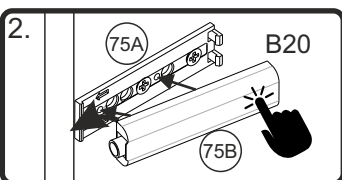
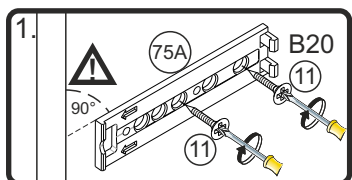
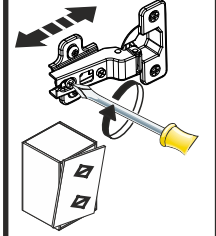
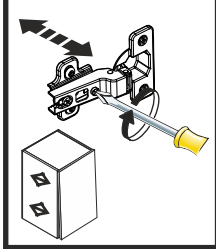
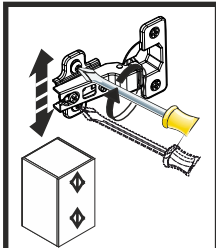
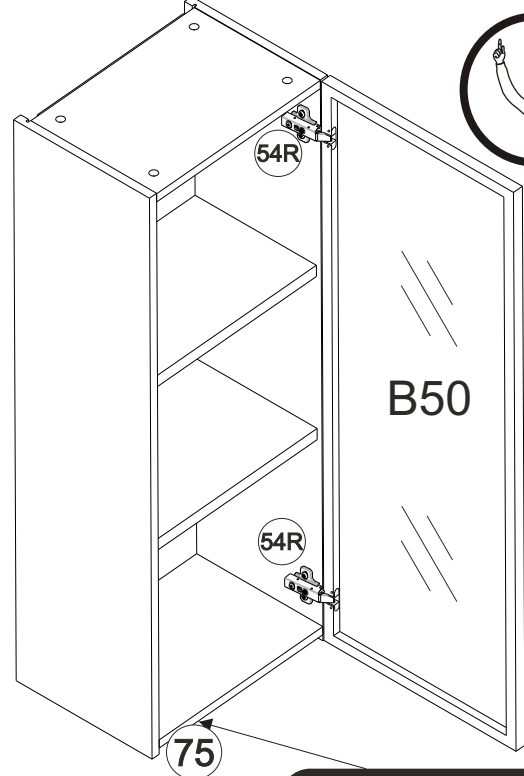
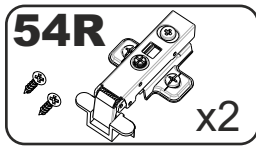
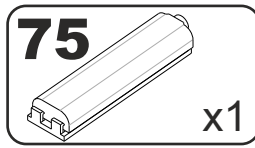
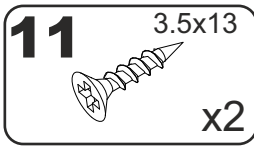
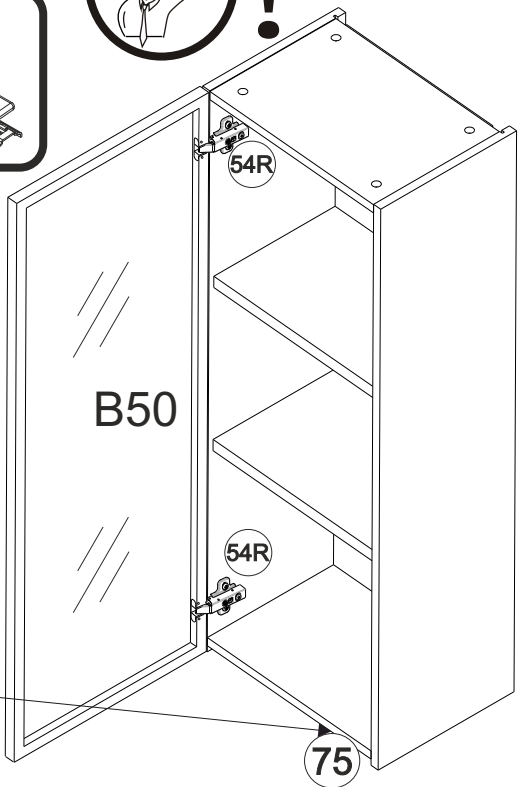
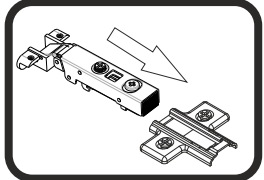

B

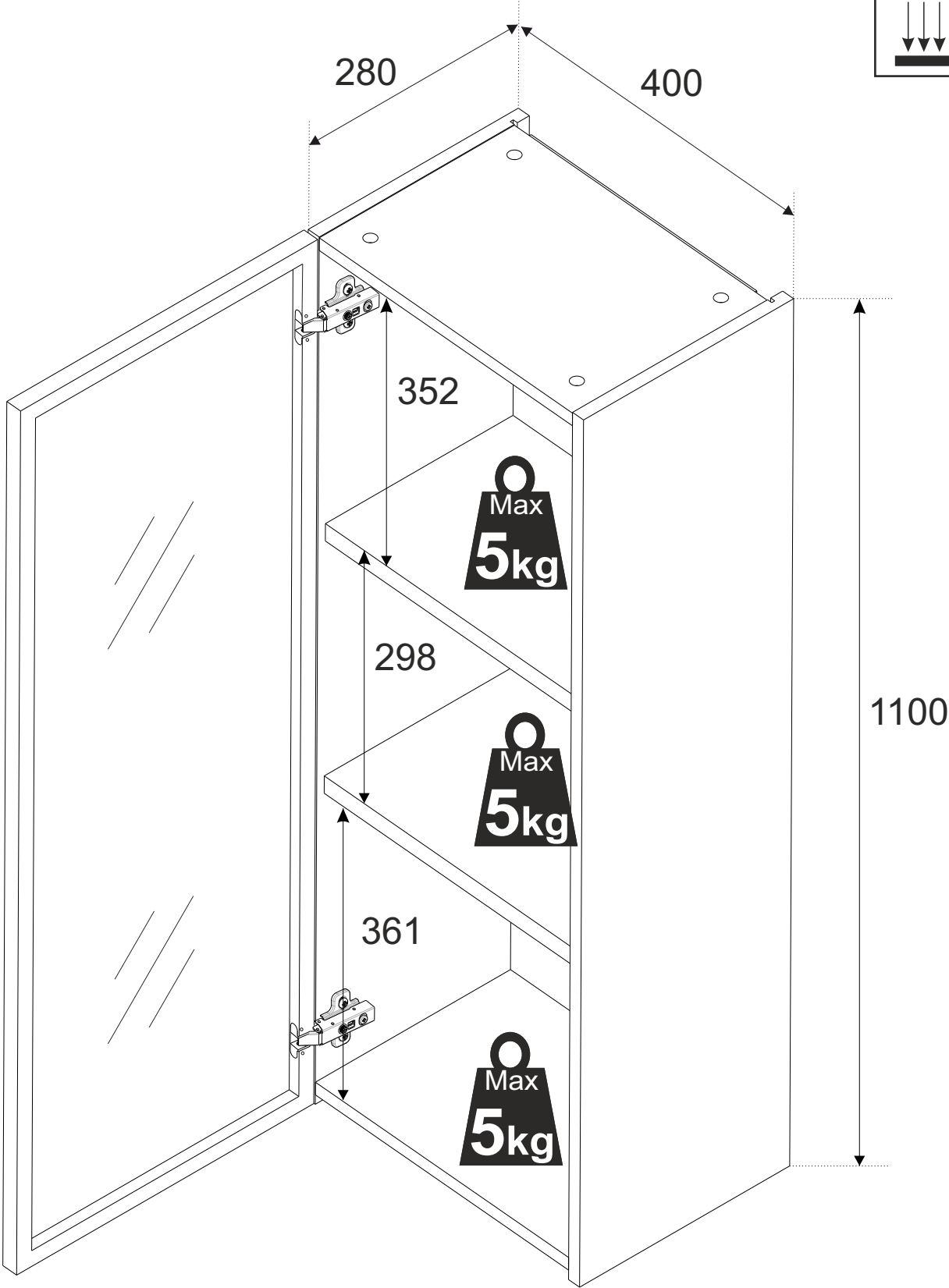
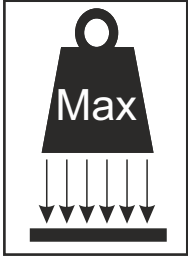

C

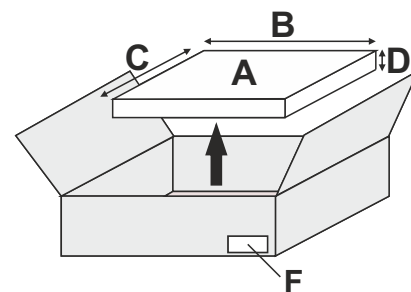
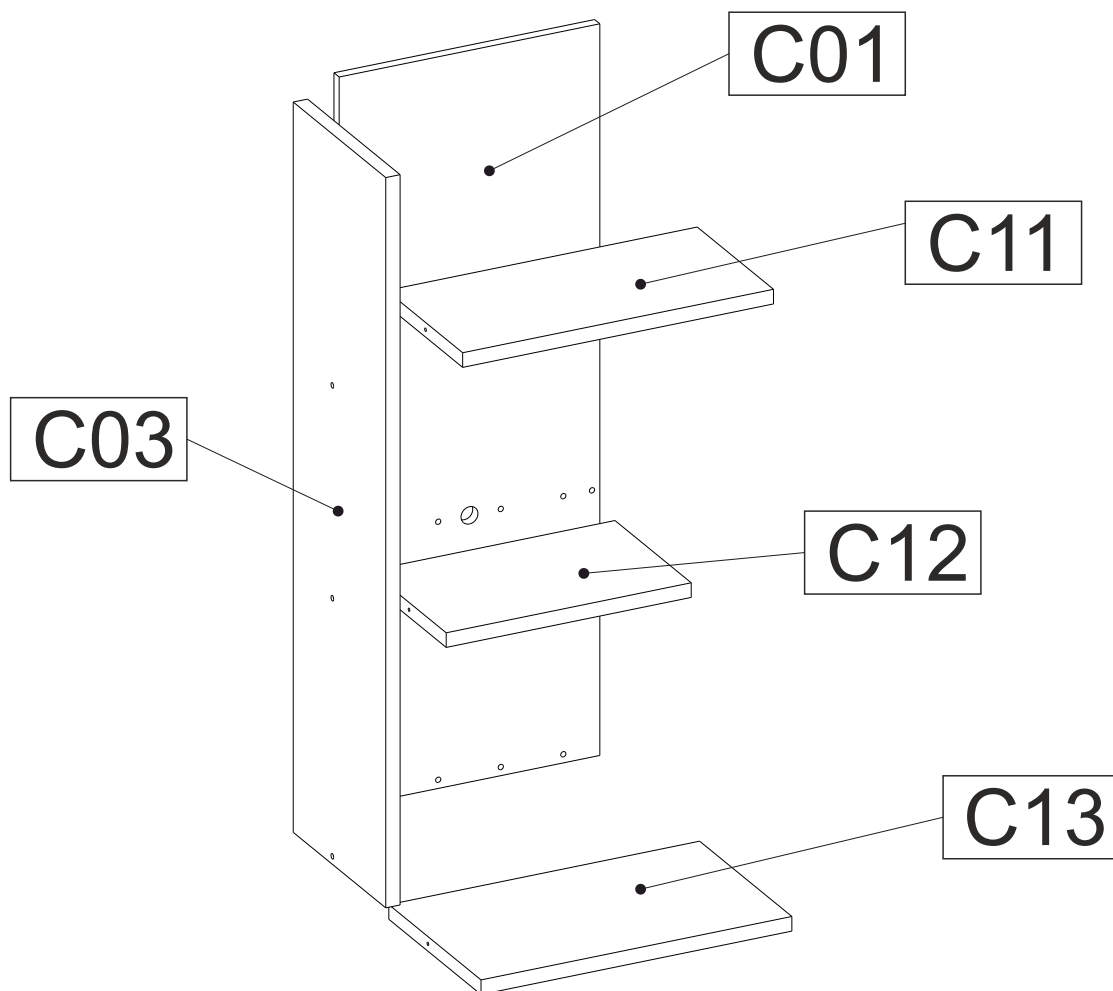

A	B_(mm)	C_(mm)	D_(mm)	E	F
C01	1100	400	16	1	3 4
C03	1098	284	22	1	4 4
C11	477	234	22	1	4 4
C12	376	234	22	1	3 4
C13	477	283	22	1	4 4

1

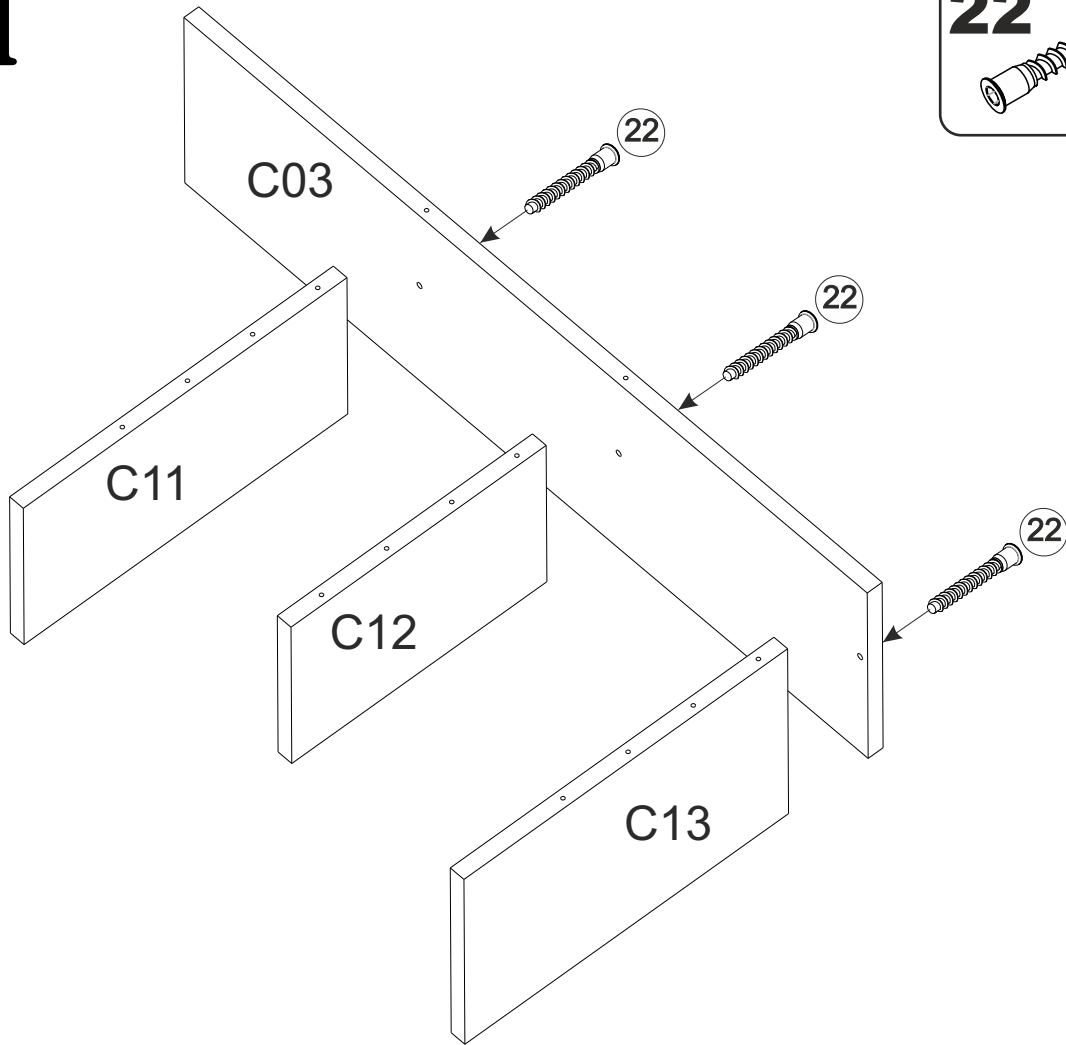

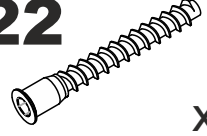

22  x3

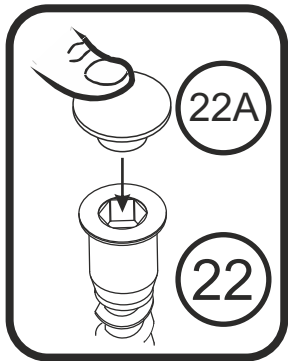
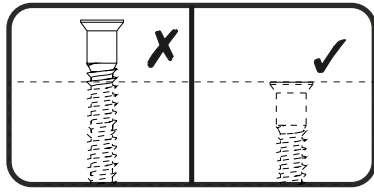
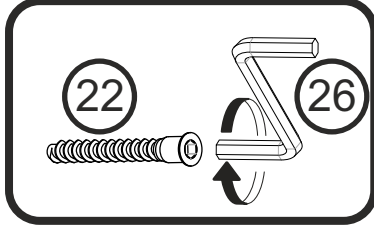
22A  x3

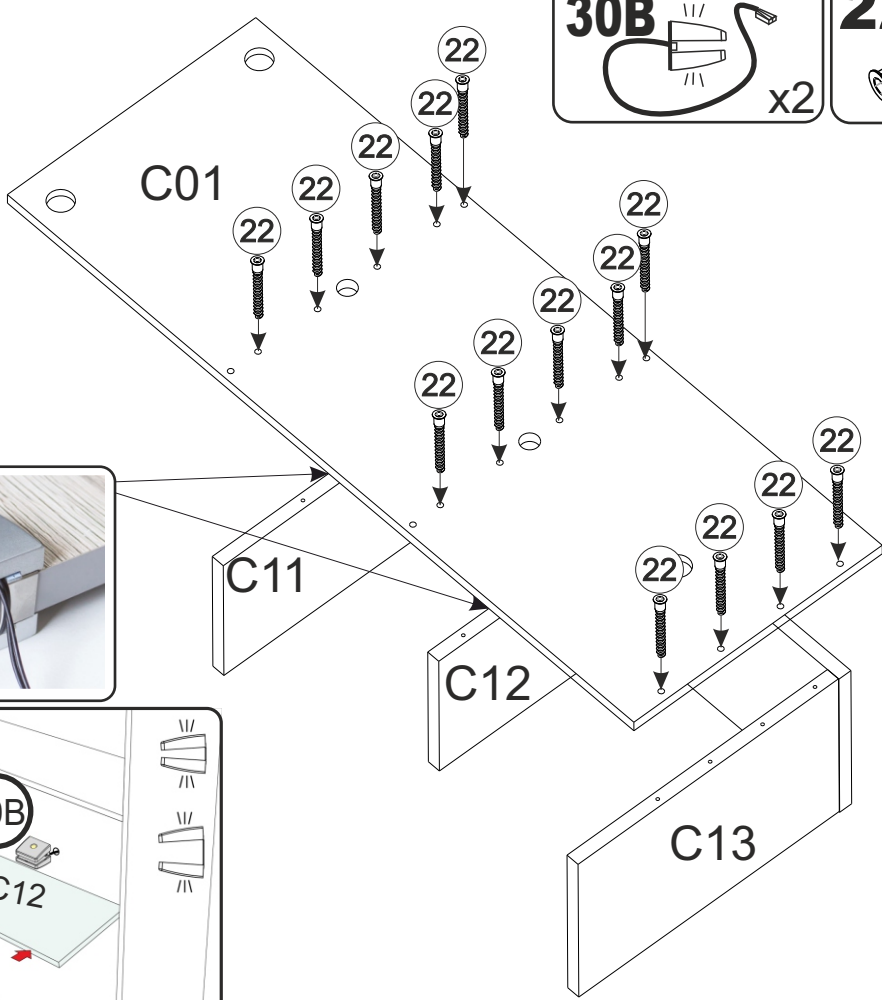

2

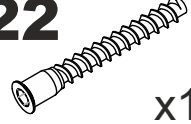

30B  x2

22  x14

22A  x14

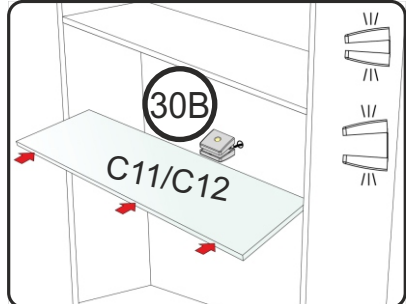
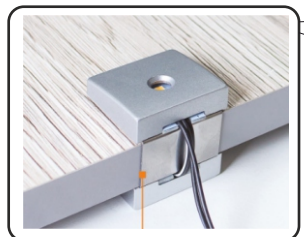
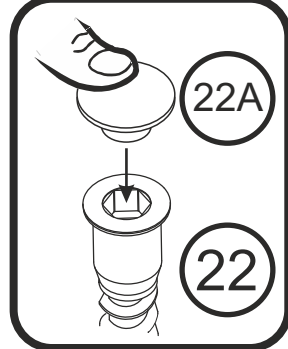
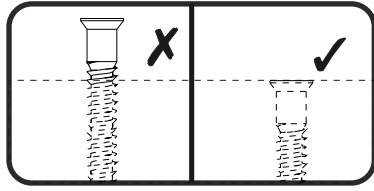
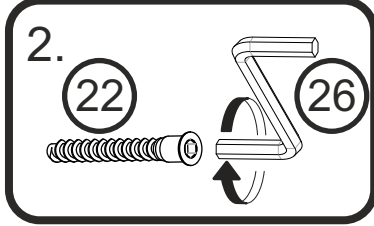

3

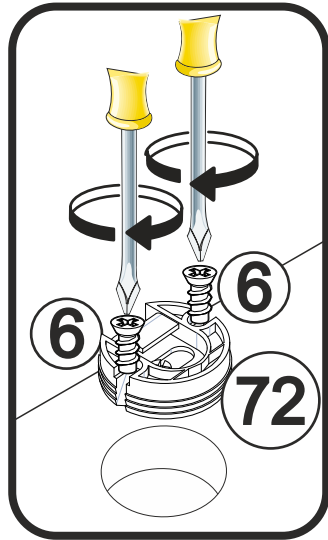
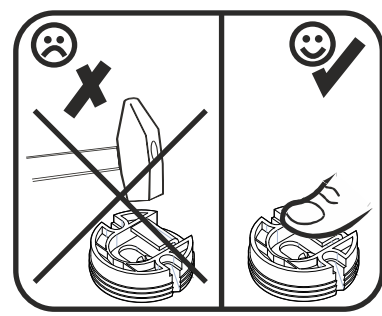
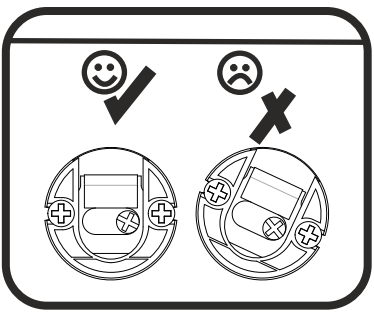
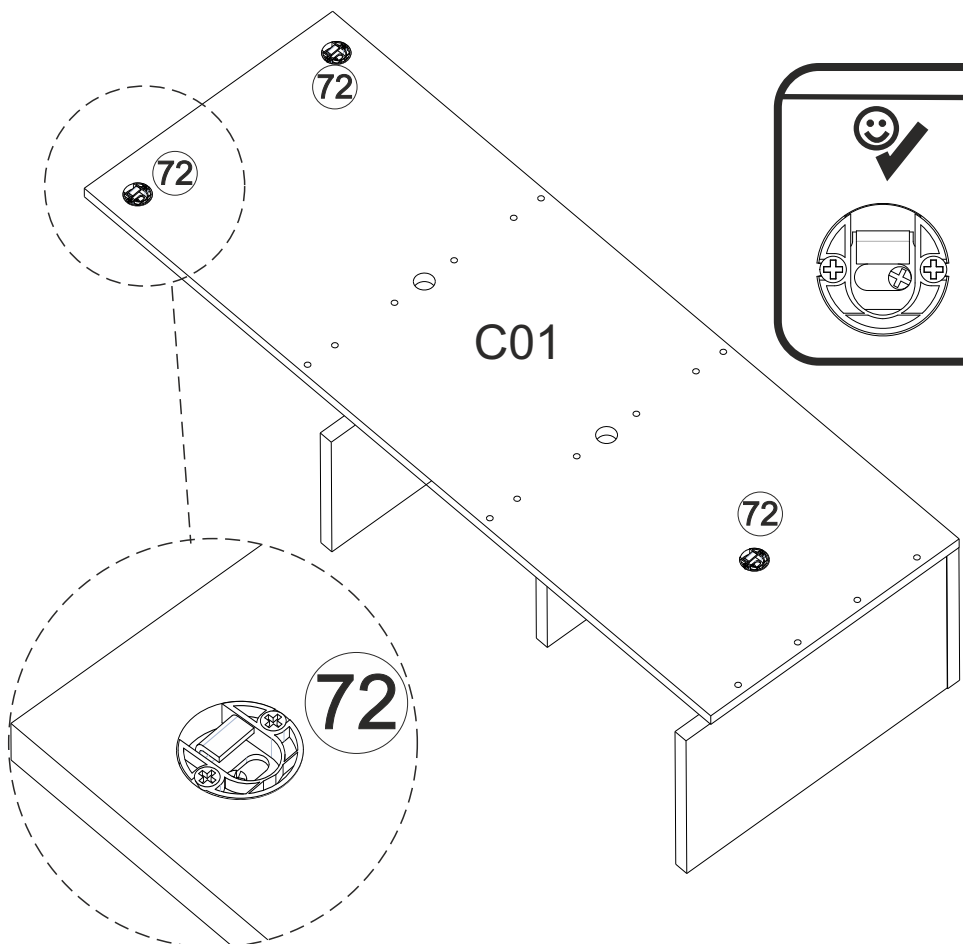
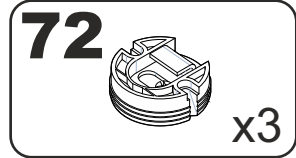
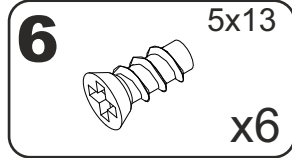

4

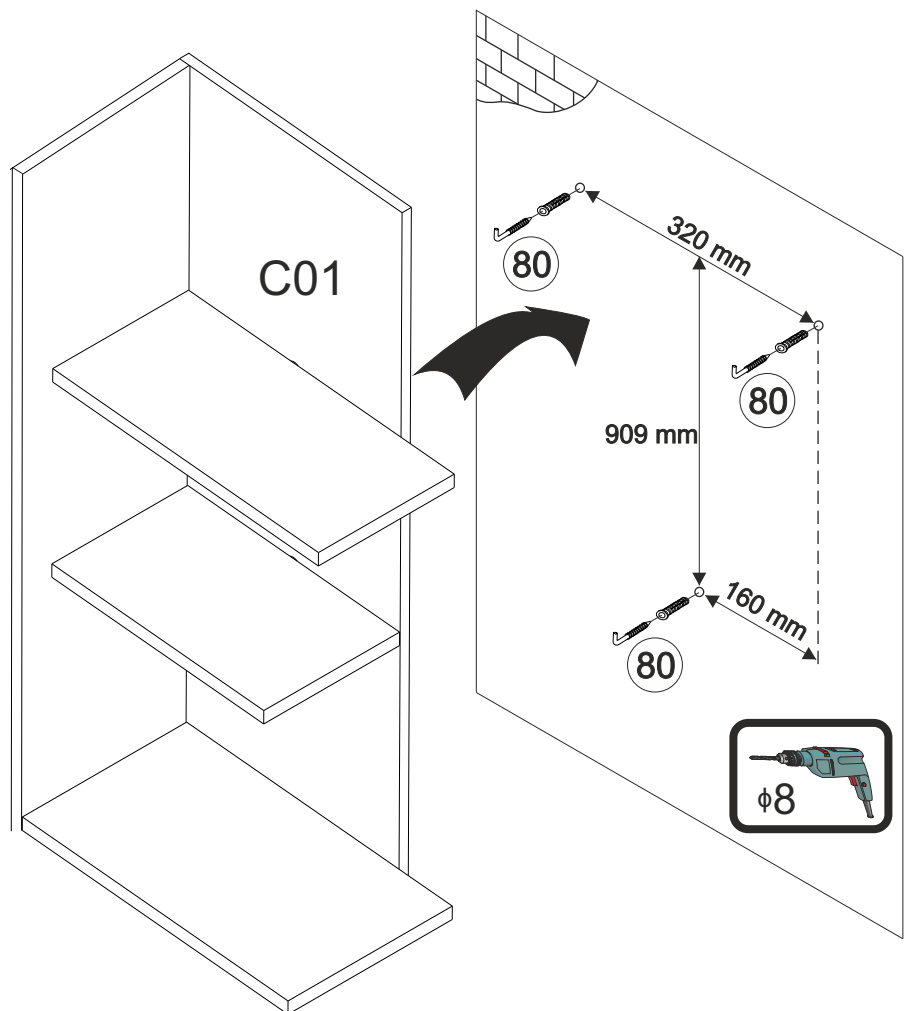
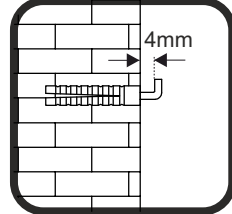
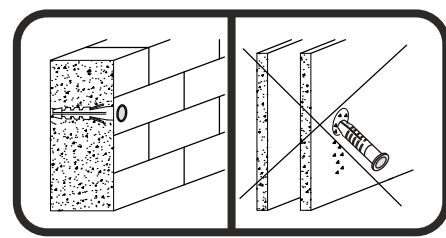
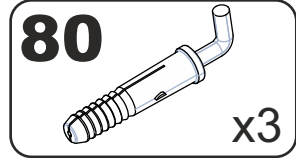

C

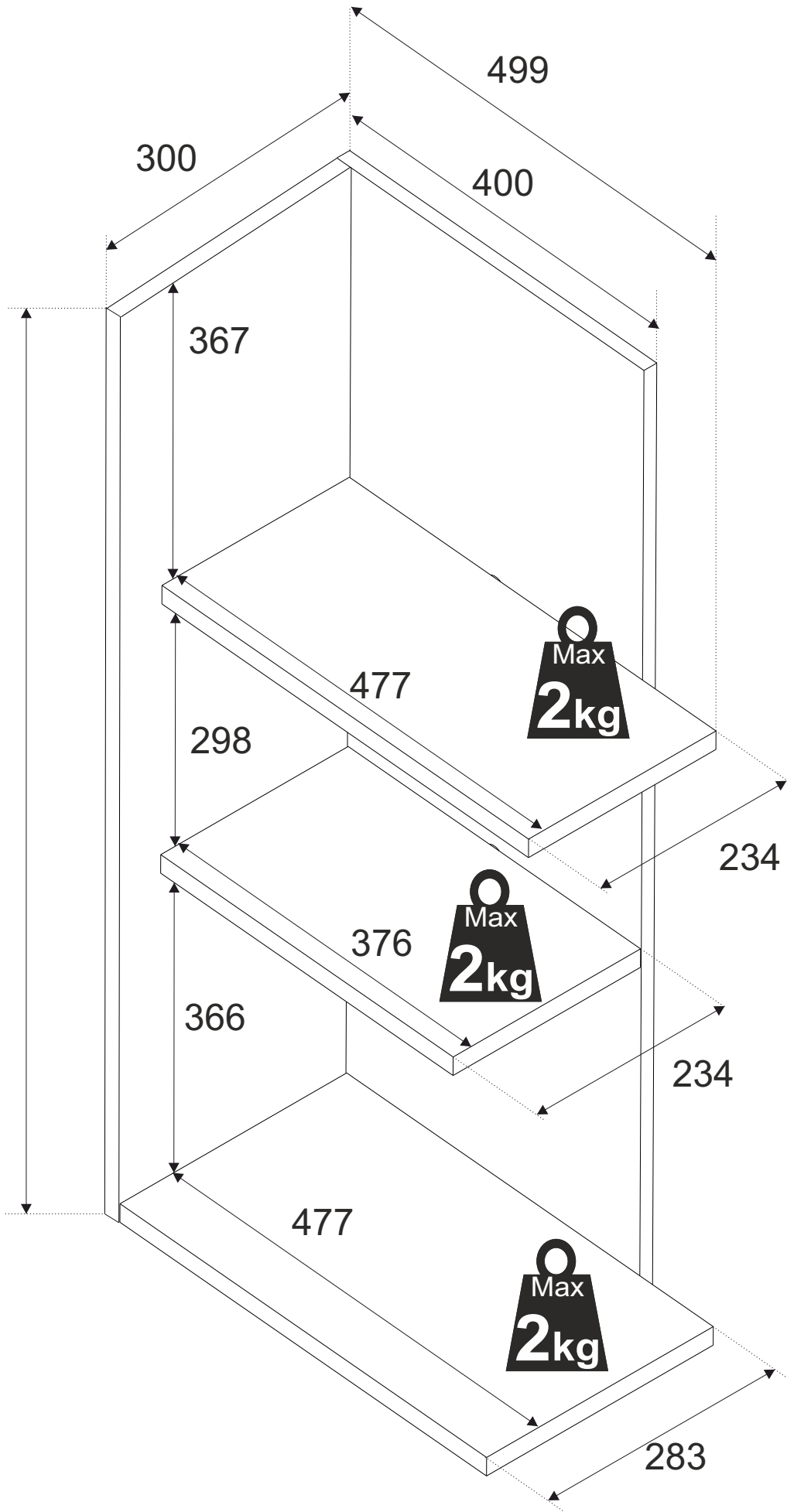
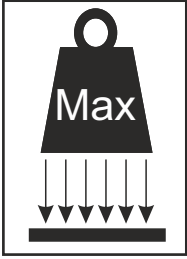

D

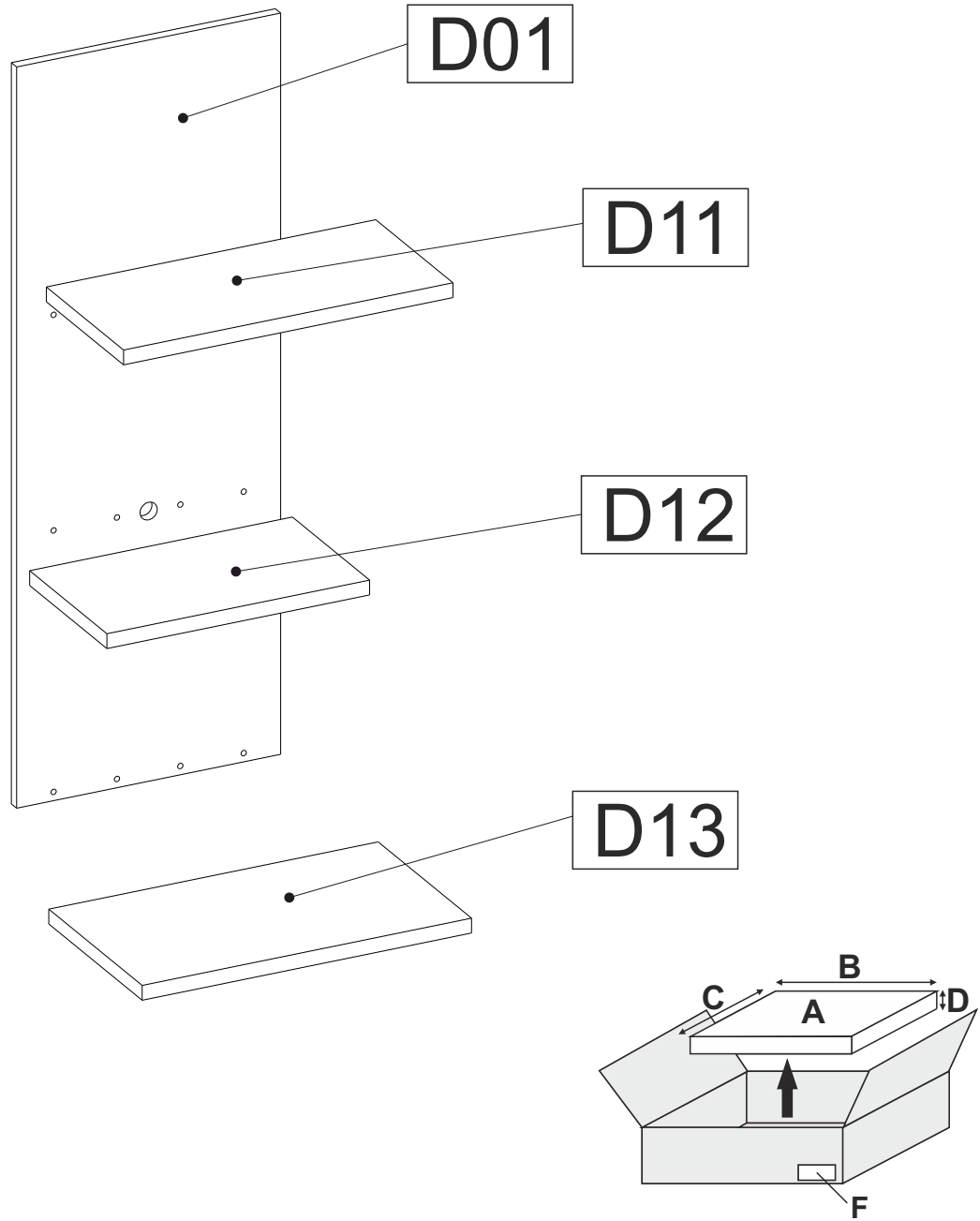

A	B_(mm)	C_(mm)	D_(mm)	E	F
D01	1100	400	16	1	3 4
D11	499	234	22	1	4 4
D12	398	234	22	1	3 4
D13	499	283	22	1	4 4

1

30B x2

22 x12

22A x12

D01

D11

D12

D13

1.

2.

3.

22

26

22A

22

6

5x13

x6

72

x3

2

D01

72

72

72

72

6

5x13

x6

72

x3

22A

22

3

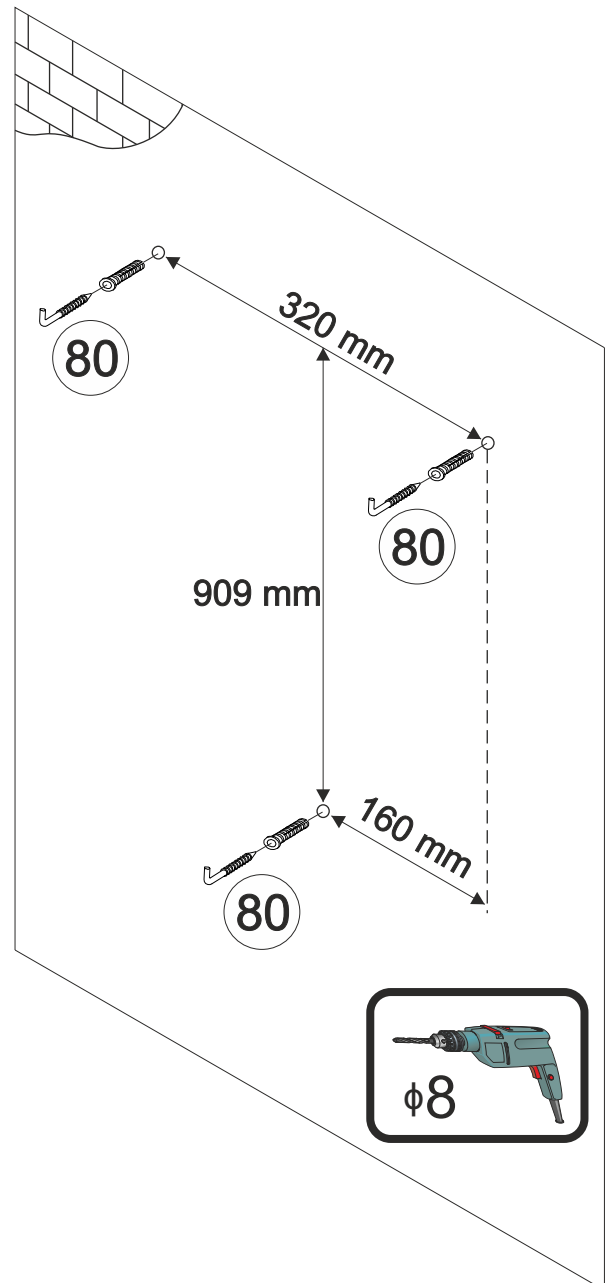
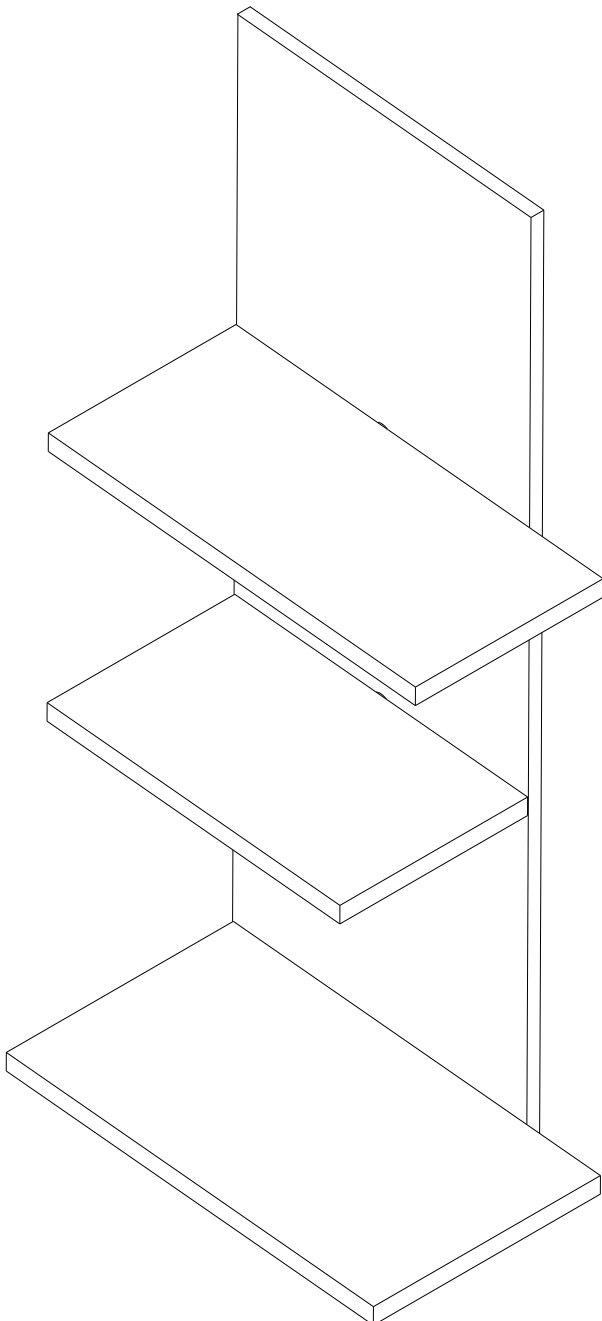
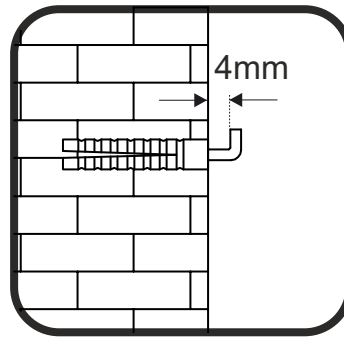
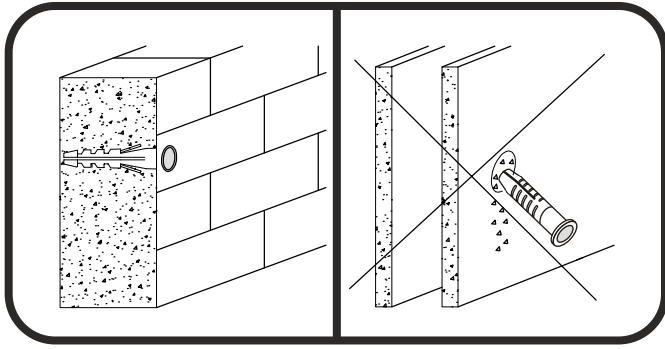
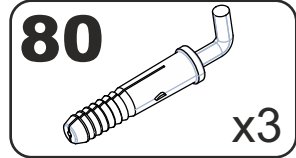

D

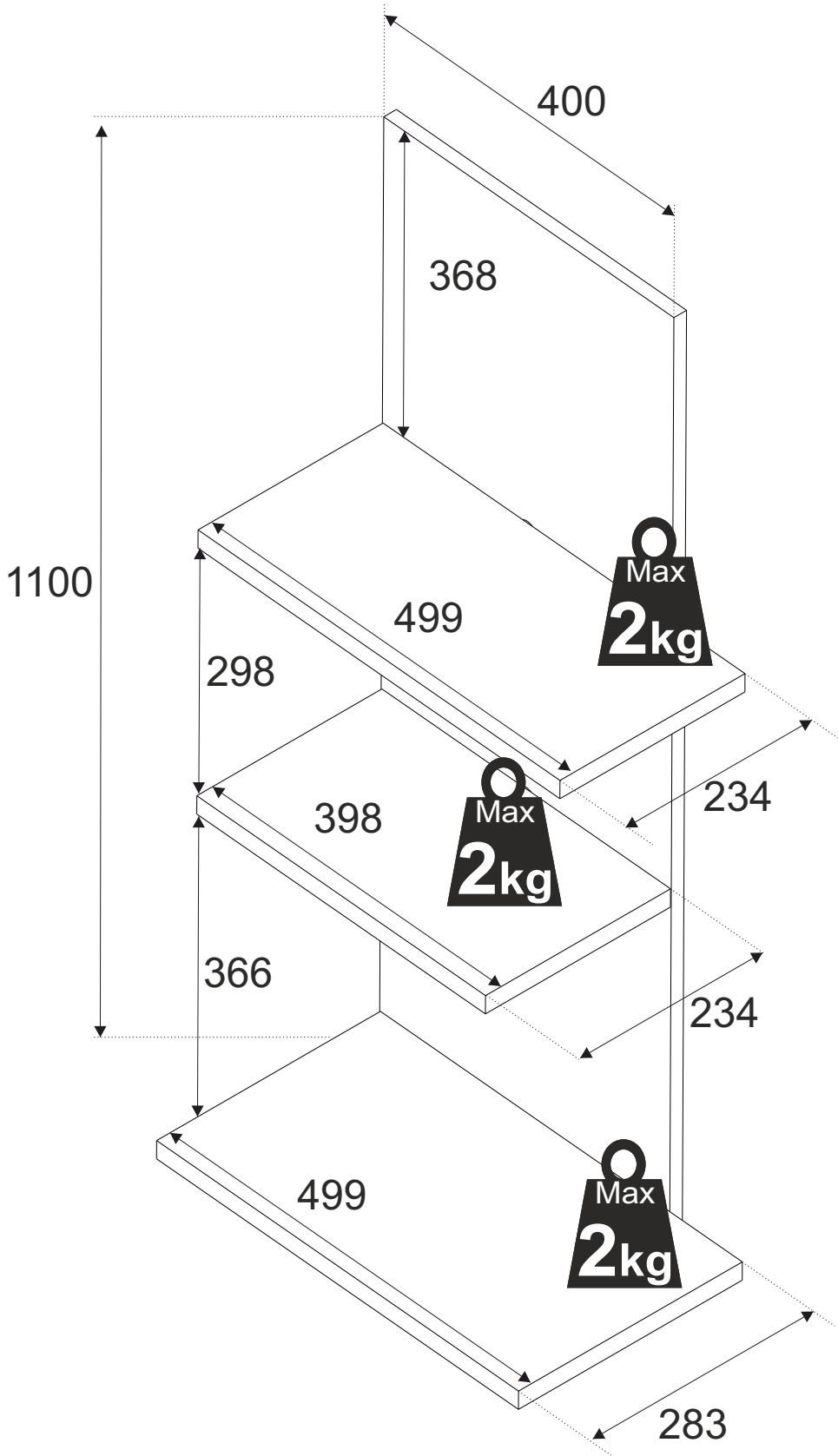
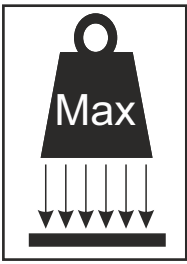

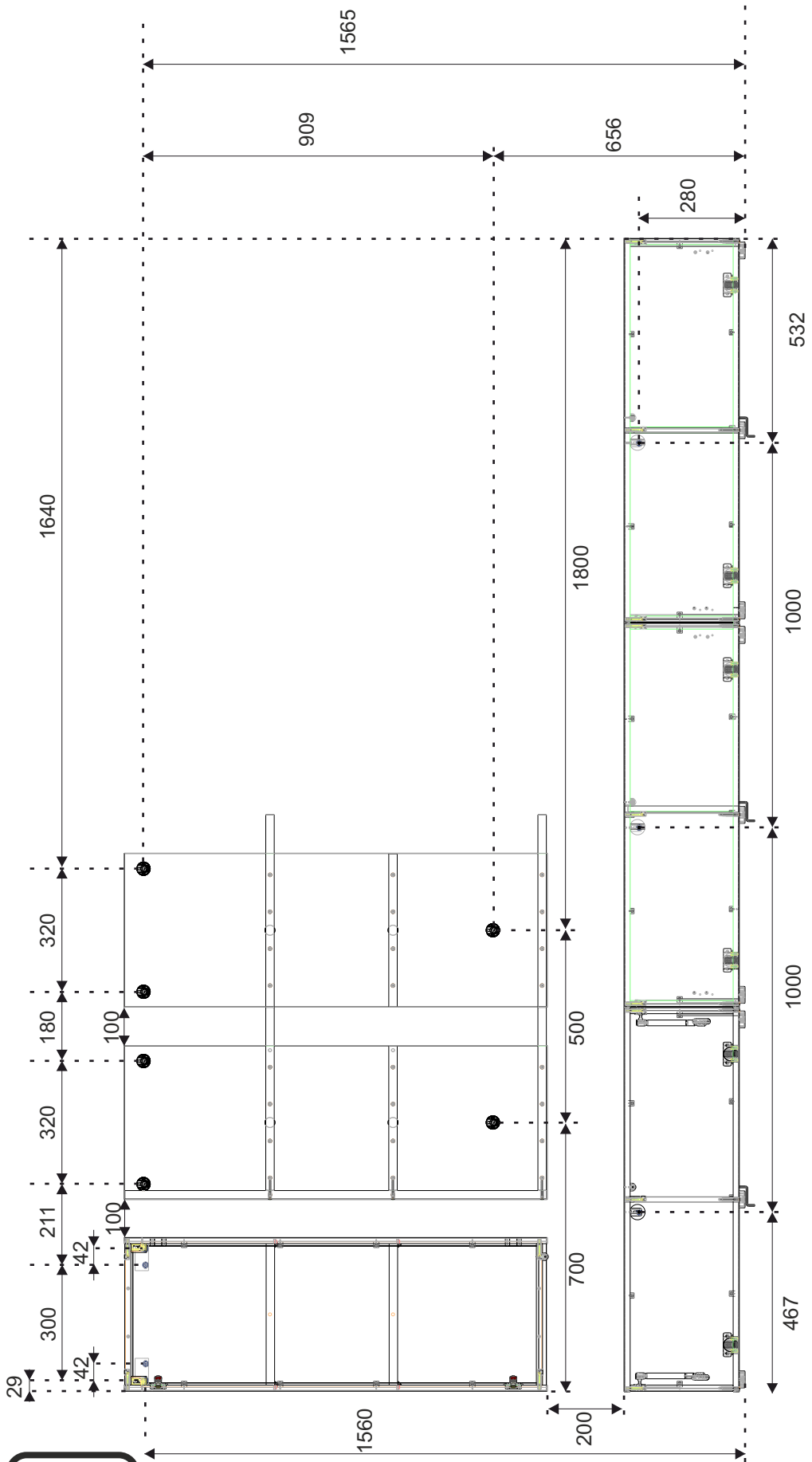
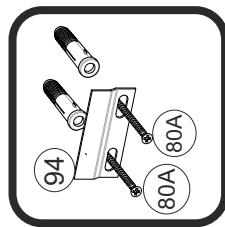
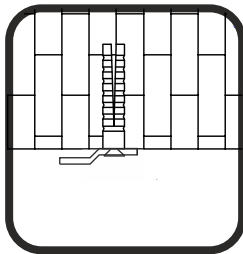
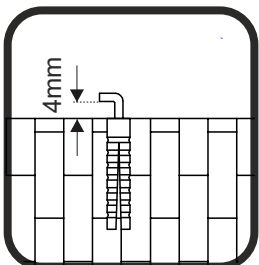
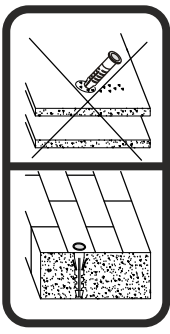
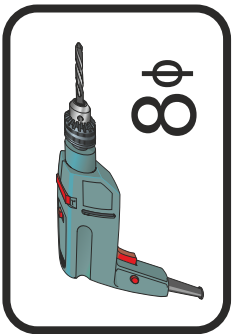

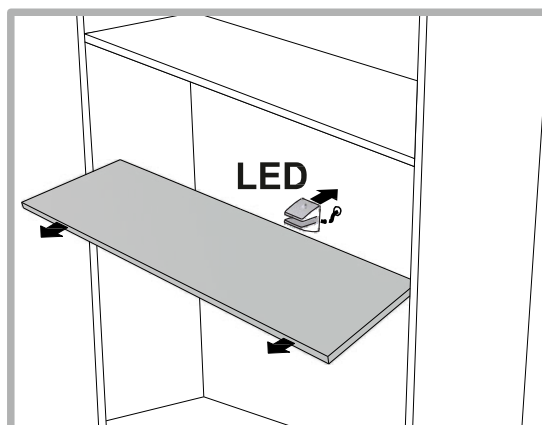
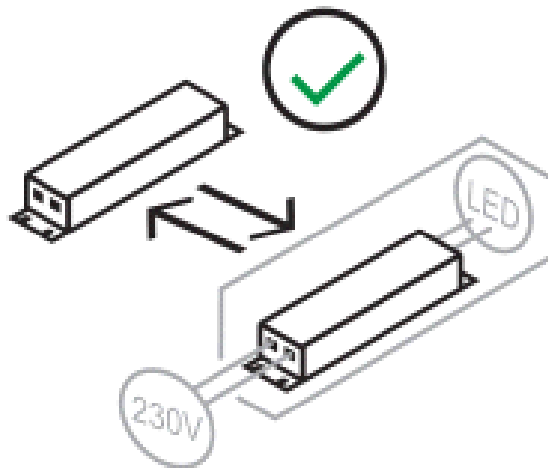
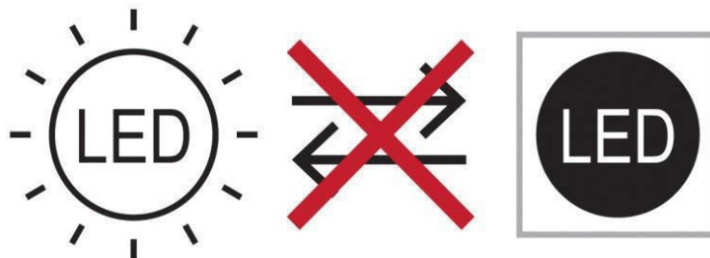

PL- Produkty te zawierają źródła światła, które ze względu na swoje właściwości nie podlegają rozporządzeniu (UE) 2019/2015

DA- Disse produkter indeholder lyskilder, som på grund af deres egenskaber er uden for anvendelsesområdet for forordning (EU) 2019/2015

ES- Estos productos contienen fuentes de luz que, por sus propiedades, quedan fuera del ámbito de aplicación del Reglamento (UE) 2019/2015.

FR- Ces produits contiennent des sources lumineuses qui, en raison de leurs propriétés, n'entrent pas dans le champ d'application du règlement (UE) 2019/2015

LT- Šiuose gaminiuose yra šviesos šaltinių, kurie dėl savo savybių nepatenka į Reglamento (UE) 2019/2015 taikymo sritį

PT- Estes produtos contêm fontes de luz que, devido às suas propriedades, estão fora do âmbito do Regulamento (UE) 2019/2015

SK- Tieto výrobky obsahujú svetelné zdroje, ktoré vzhľadom na svoje vlastnosti nepatria do rozsahu pôsobnosti nariadenia (EÚ) 2019/2015

TR- Bu ürünler, özellikleri nedeniyle (UE) 2019/2015 Yönetmeliğinin kapsamı dışında kalan ışık kaynakları içerir.

DE- Diese Produkte enthalten Lichtquellen, die aufgrund Ihrer Eigenschaften nicht unter die Verordnung (EU) 2019/2015 fallen

EL- Αυτά τα προϊόντα περιέχουν πηγές φωτός οι οποίες, λόγω των ιδιοτήτων τους, δεν εμπίπτουν στο πεδίο εφαρμογής του κανονισμού (UE) 2019/2015

ET- Need tooted sisaldavad valgusallikaid, mis oma omaduste tõttu jäävad määruse (UE) 2019/2015 reguleerimisalast välja

HU- Ezek a termékek olyan fényforrásokat tartalmaznak, amelyek tulajdonságaik miatt nem tartoznak az (EU) 2019/2015 rendelet hatálya alá

LV- Šie produkti satur gaismas avotus, kas to īpašību dēļ ir ārpus Regulas (UE) 2019/2015 darbības jomas

RO- Aceste produse conțin surse de lumină care, datorită proprietăților lor, nu intră în domeniul de aplicare al Regulamentului (UE) 2019/2015

SLO- Ti izdelki vsebujejo svetlobne vire, ki zaradi svojih lastnosti ne spadajo na področje uporabe Uredbe (EU) 2019/2015

HR- Ovi proizvodi sadrže izvore svjetlosti koji zbog svojih svojstava nisu obuhvaćeni Uredbom (EU) 2019/2015

CS- Tyto výrobky obsahují světelné zdroje, které vzhledem ke svým vlastnostem nespadají do oblasti působnosti nařízení (EU) 2019/2015

EN- These products contain light sources which, due to their properties, are out of the scope of Regulation (EU) 2019/2015

FI- Nämä tuotteet sisältävät valonlähteitä, jotka ominaisuuksiensa vuoksi eivät kuulu asetuksen (EU) 2019/2015 soveltamisalaan

IT- Questi prodotti contengono sorgenti luminose che, per le loro proprietà, esulano dal campo di applicazione del Regolamento (UE) 2019/2015

RU- Эти продукты содержат источники света, которые из-за своих свойств не подпадают под действие Регламента (EC) 2019/2015.

NL- Deze producten bevatten lichtbronnen die vanwege hun eigenschappen buiten het toepassingsgebied van Verordening (EU) 2019/2015 vallen

SV- Dessa produkter innehåller ljuskällor som på grund av sina egenskaper inte omfattas av förordning (EU) 2019/2015

BG- Тези продукти съдържат източници на светлина, които поради своите свойства са извън обхвата на Регламент (EC) 2019/2015