

- | | | | | | | | | | | | | |
|------------------|------------------|---------------|---------------|---------------|---------------|---------------|---------------|---------------|----------------|----------------|--------------|---------------|
| 1x

n165/P | 1x

n165/L | 4x

J1 | 10x

I2 | 1x

a45 | 1x

b20 | 1x

p75 | 1x

a44 | 1x

b19 | 4 x

p51 | 10x

p55 | 4x

e2 | 4x

f35 |
| 8x

s2 | 8x

r1 | 8x

r23 | 8x

f1 | | | | | | | | | |

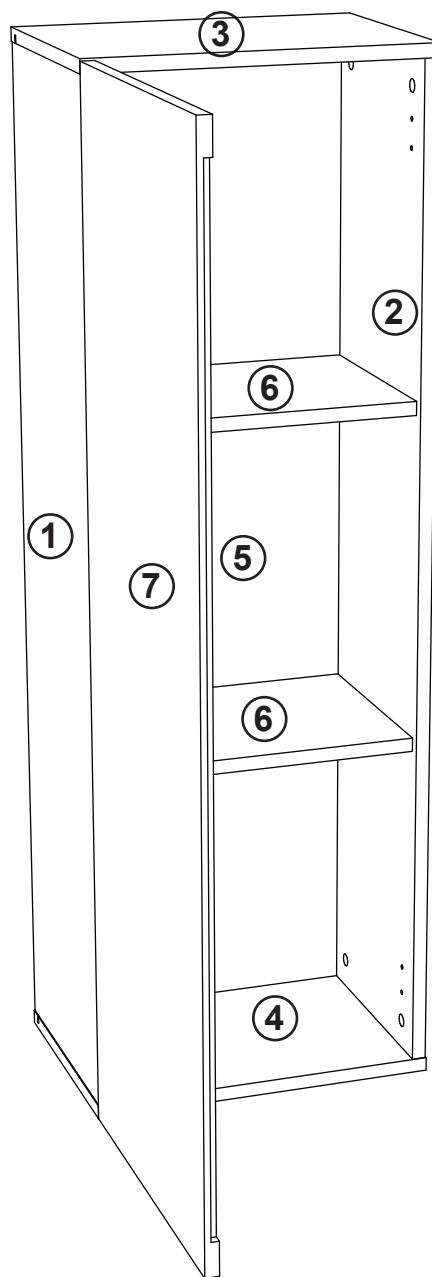
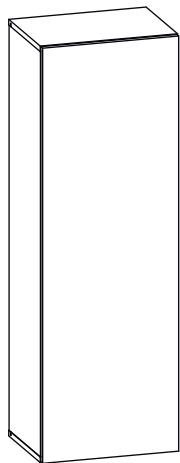

A	B	C (mm)		Colli
1	001	1168	281	1/1
2	002	1168	281	1/1
3	003	400	282	1/1
4	004	400	282	1/1
5	005	1182	380	1/1
6	006	365	250	1/1
7	007	1196	396	1/1

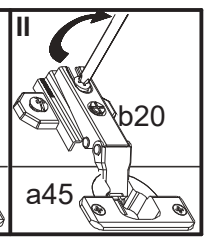
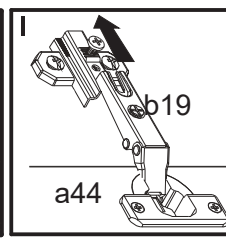
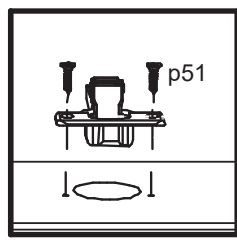
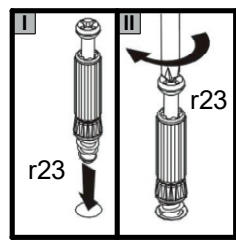
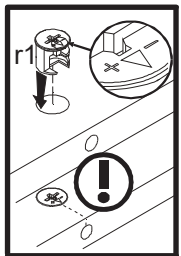
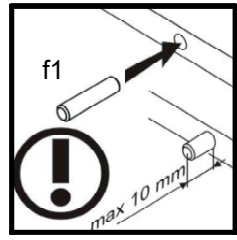
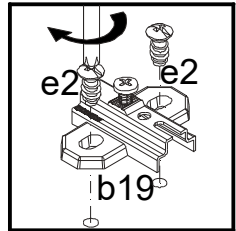
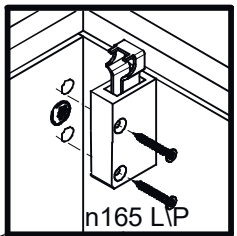
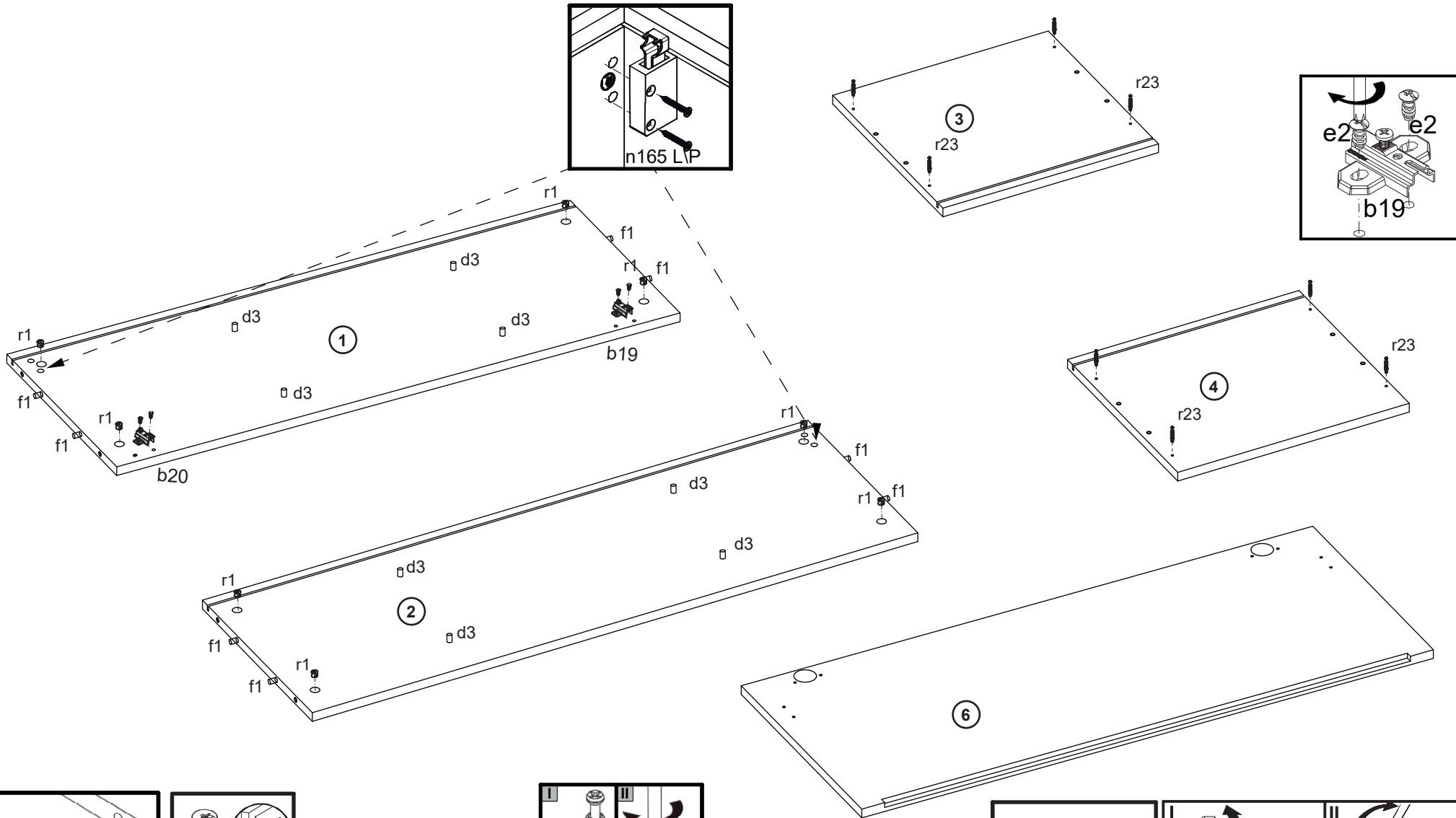

2

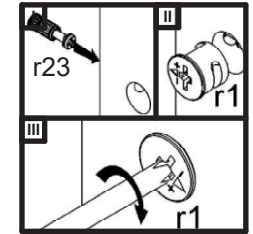
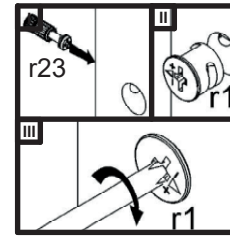
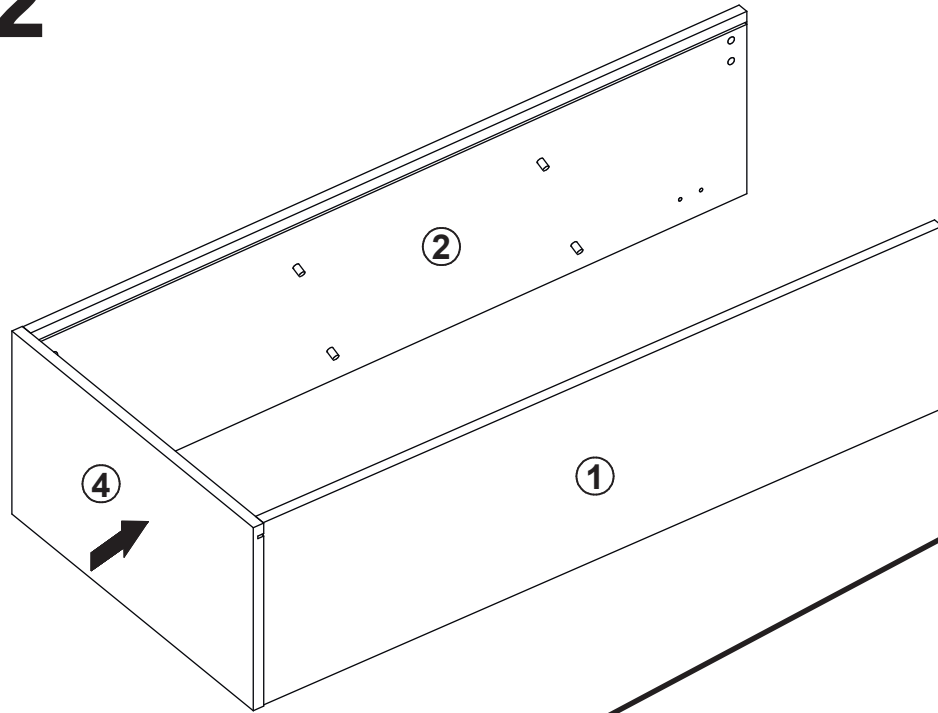

3

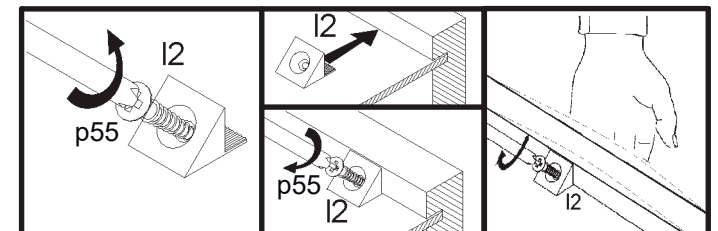
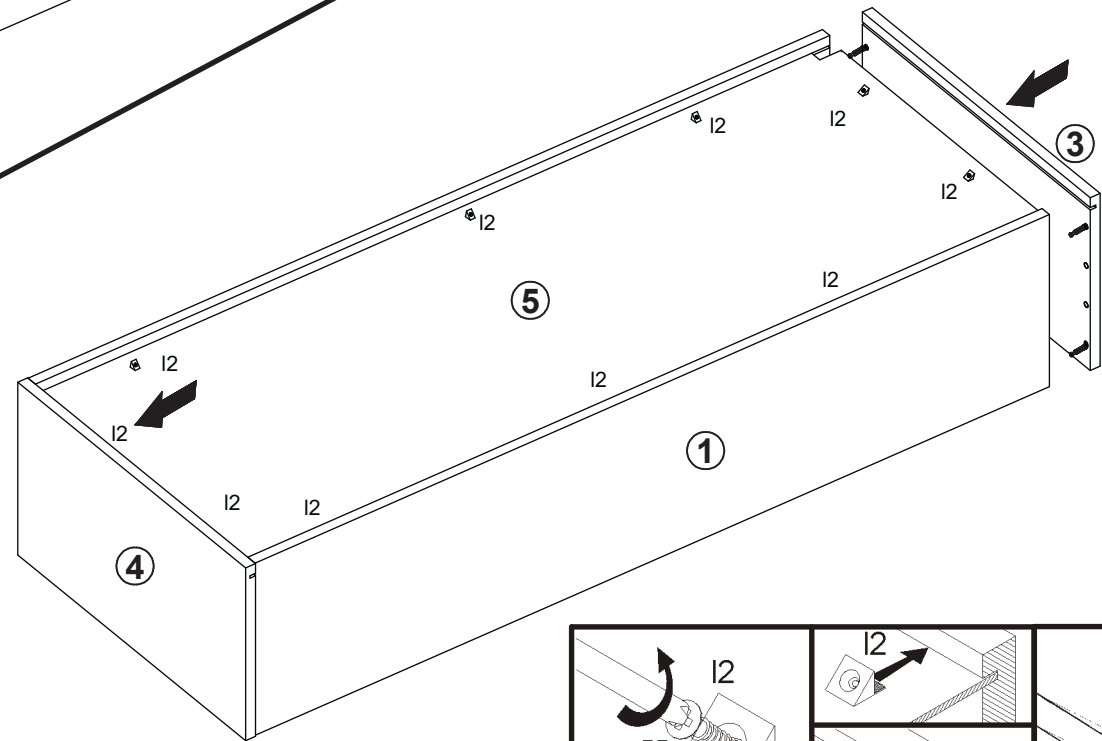

4

