

(Š) B - 1550mm  
(V) H - 200mm  
(H) T - 235mm

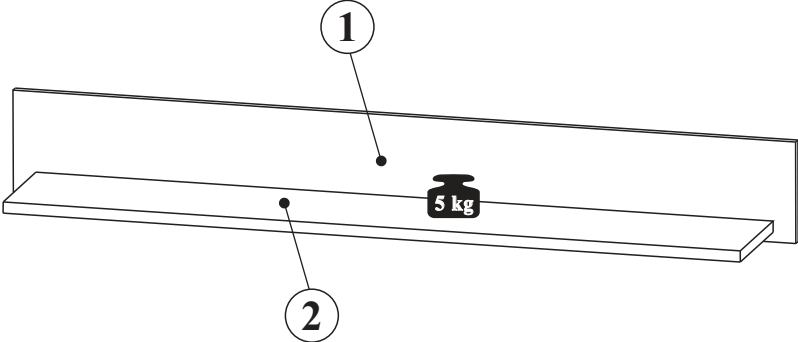

- NR 1**
- K2** 7x70 x10
  - T10** x3
  - T13** 8x50 mm x4
  - S25** 4x70 x1
  - C13** φ14mm x1
  - C18** 5mm x3

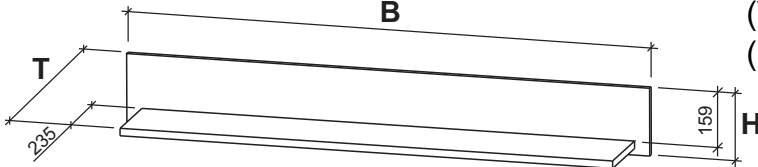

1	1550	200	1	1/1
2	1460	235	1	1/1

1

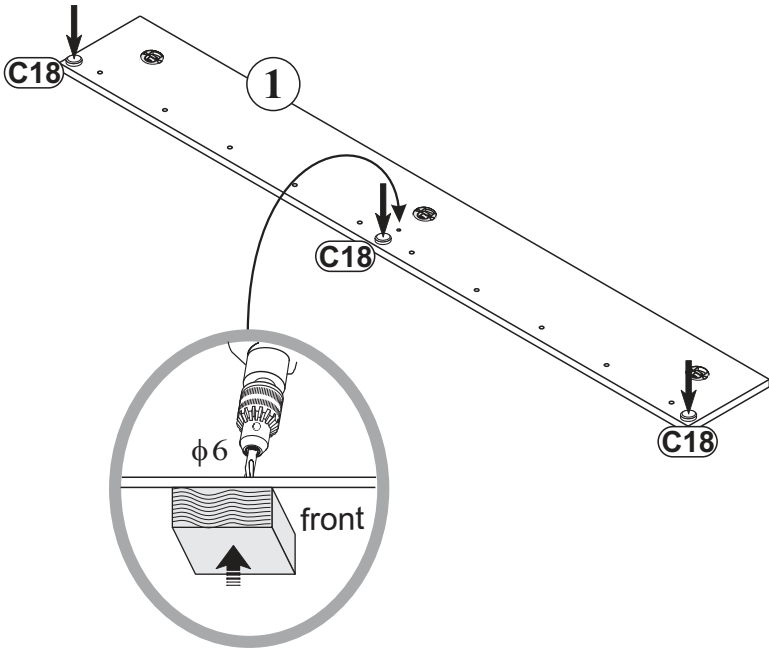
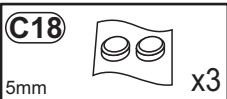

2

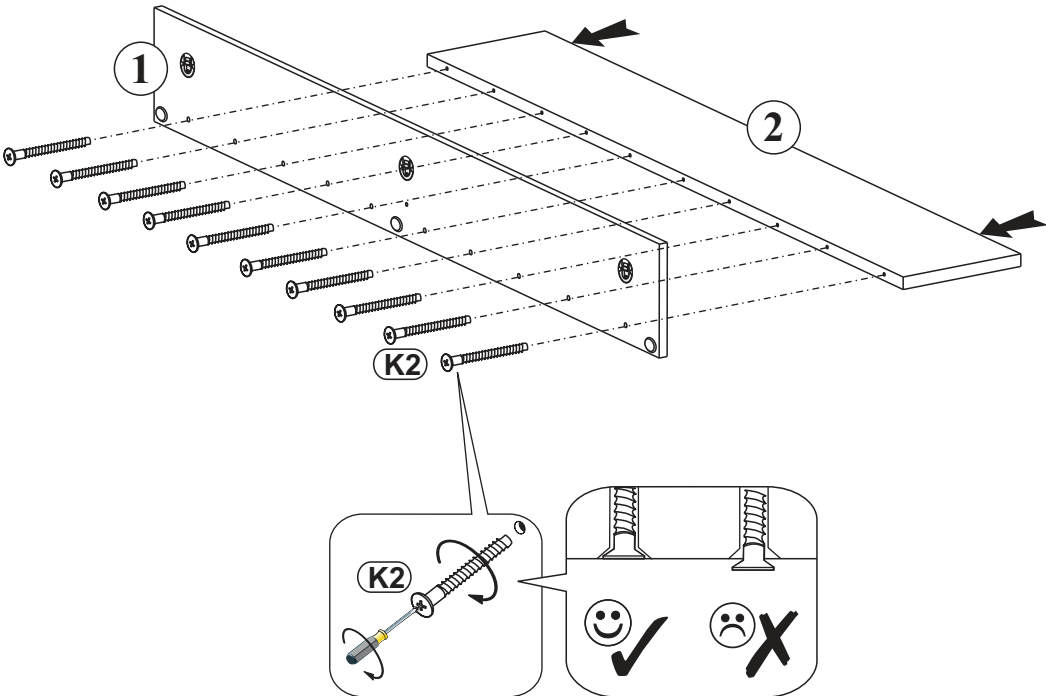
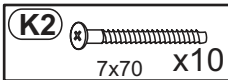

### 3

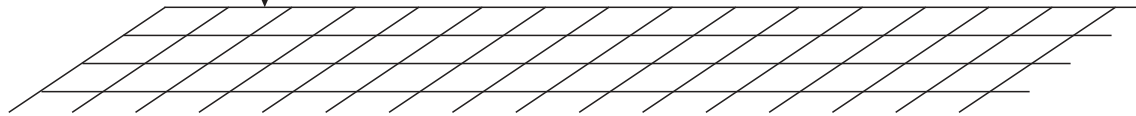
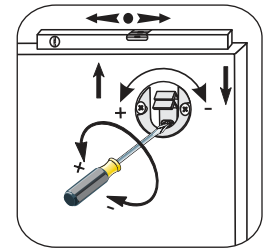
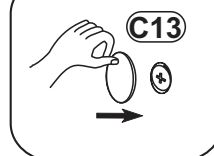
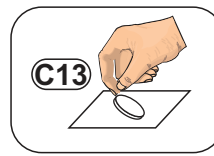
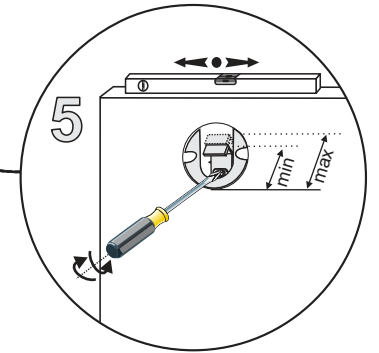
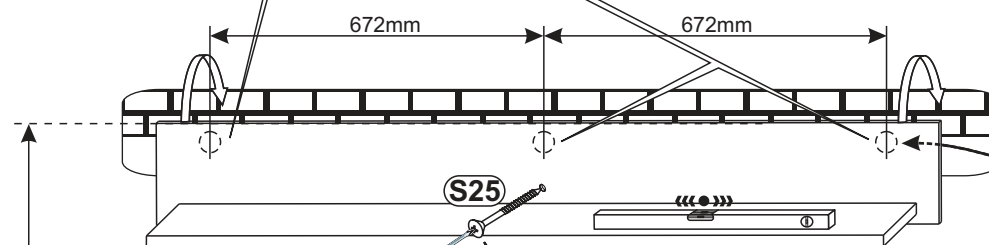
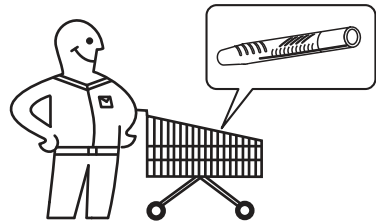
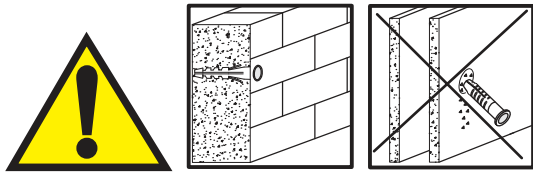
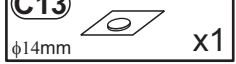
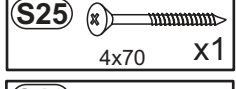
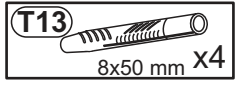
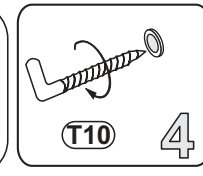
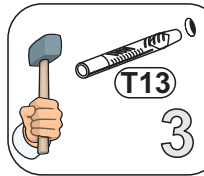
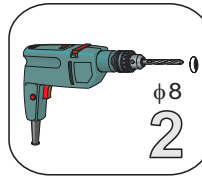
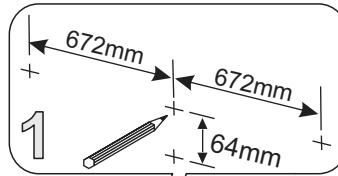
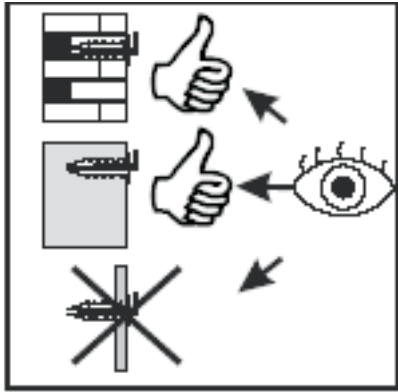

## 81

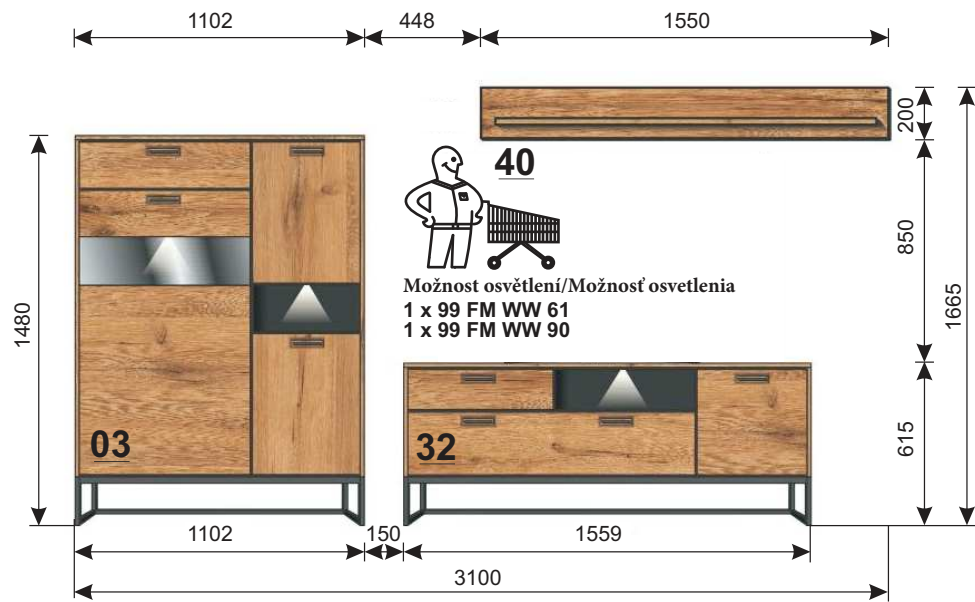

## 84

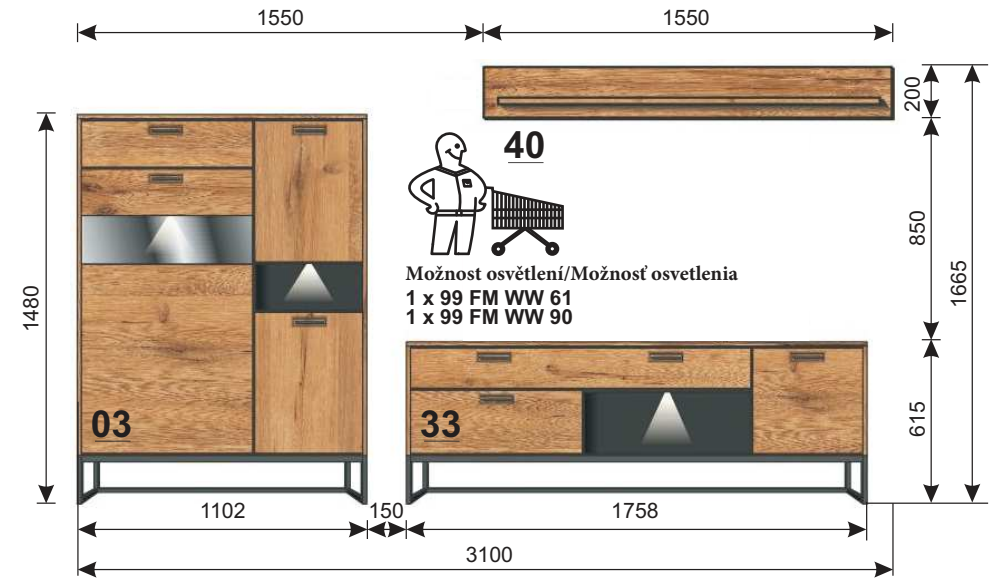

## 86

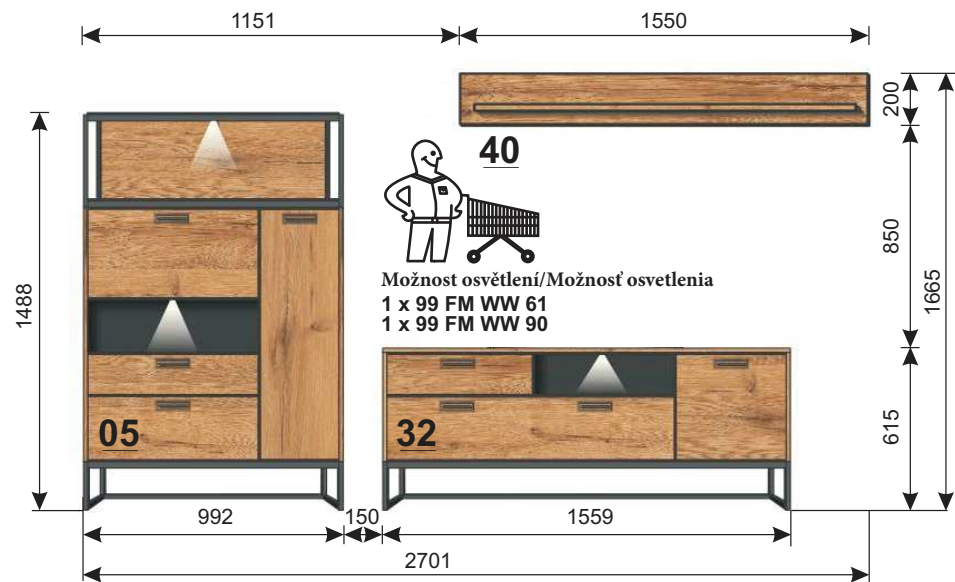

## 88

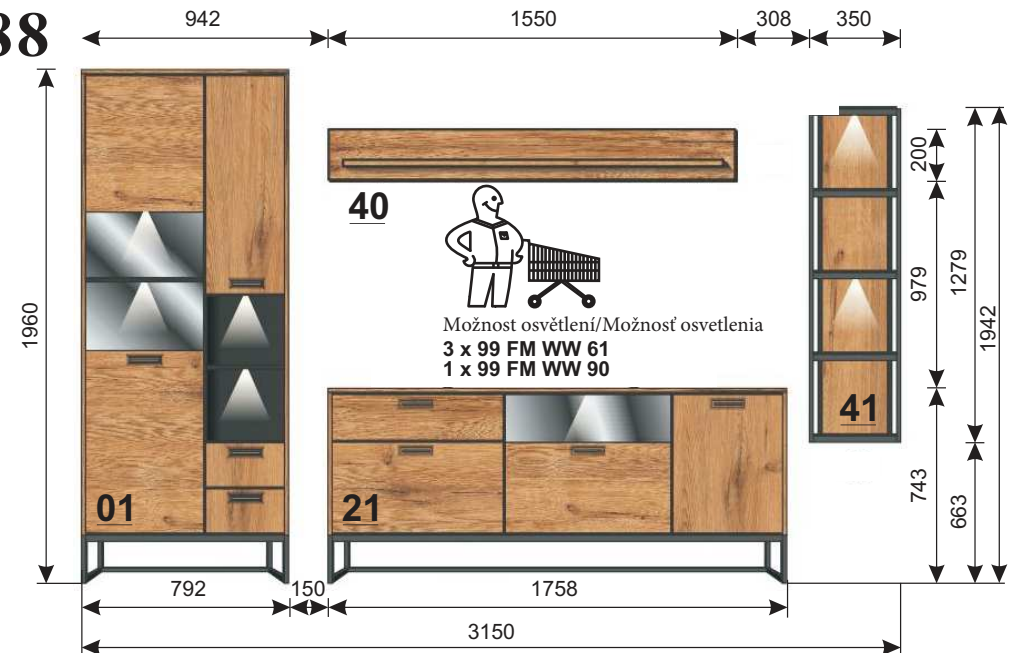

# MANHATTAN / SWEEP 1011

# 4023--40

# 6 / 6

89

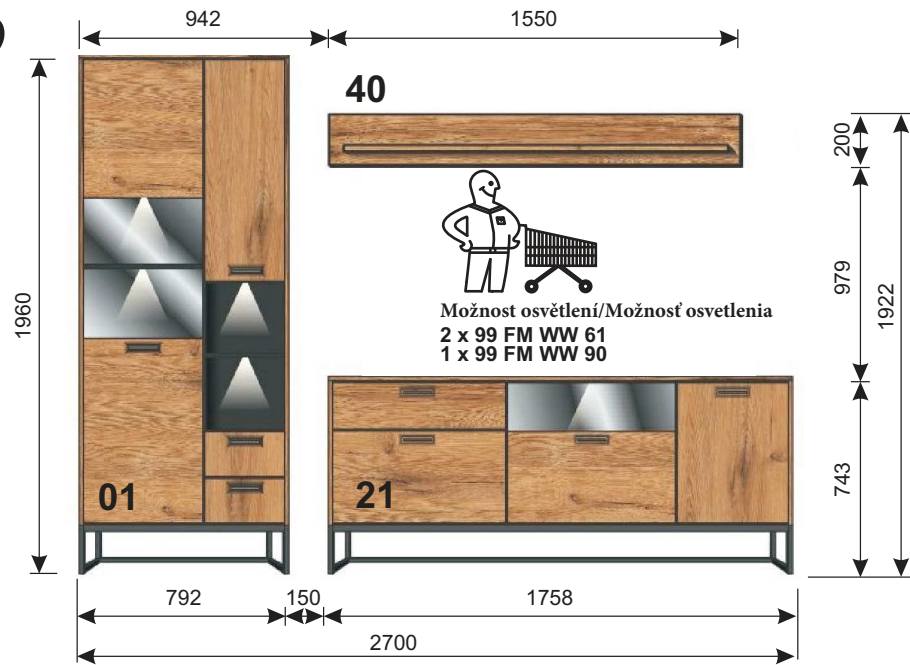

91

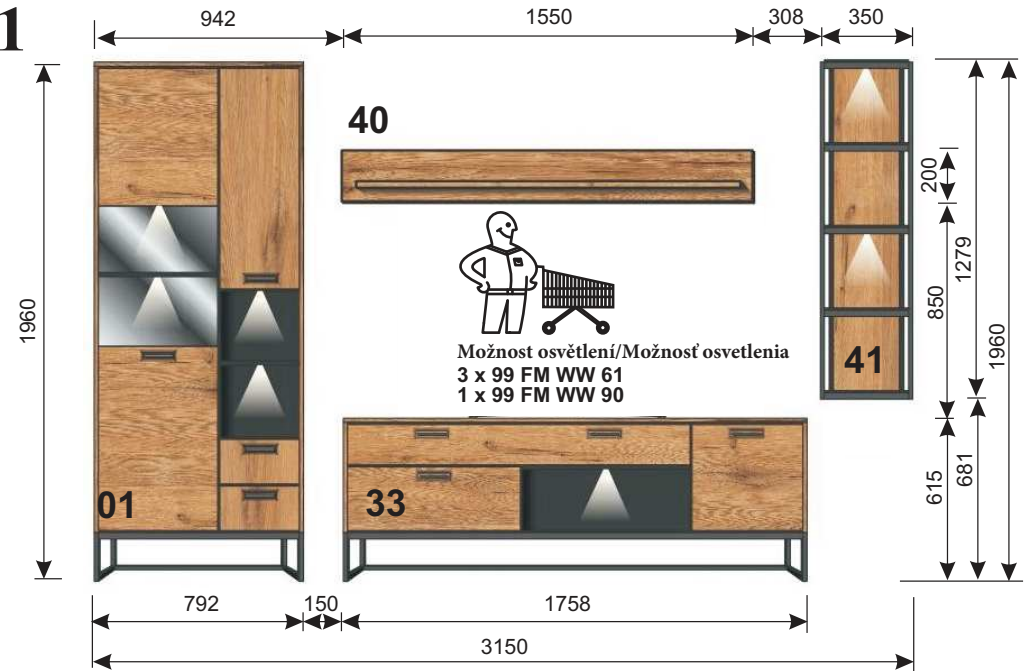

<b>D CH AT LI LU</b>	Kleinteile und Verpackungsfolien bei der Möbelmontage von Kindern fernhalten!
<b>GB US</b>	Keep small parts and plastic film out of the reach of children!
<b>FR BE NC</b>	Tenir les petites pièces et les films plastiques hors de la portée des enfants!
<b>NL</b>	Houd de kleine onderdelen en de plastic folie uit de buurt von kinderen!
<b>IT</b>	Tenere i componenti di piccole dimensioni e le pellicole di plastica fuori dalla portata dei bambini!
<b>SI</b>	Majhnih delov in embalažne folije pri montaži pohištva hranite izven dosega otrok!
<b>XS HR BA</b>	Male dijelove i foliju za pakovanje prilikom montaže namještaja držite dalje od djece
<b>HU</b>	Bútorszerelés közben a kis alkatrészek és a csomagoló fóliák gyermekektil távol tartandók!
<b>BG</b>	Дребни детайли и опаковъчни фолиа да се държат далеч от деца при монтажа на мебелите!
<b>CZ SK</b>	Při montáži nábytku uchovávejte drobné díly a obalové fólie z dosahu dětí!
<b>SE</b>	Vid möbemontering ska smådelar och förpackningsfolien hållas oåtkomliga för barn!
<b>RO</b>	Țineți departe de copii piesele mici și folia de ambalat la montarea mobilei!
<b>ES</b>	¡Durante el montaje, mantenga alejados de los niños las piezas pequeñas y el material plástico de embalaje!
<b>D CH AT LI LU</b>	Möbelmontage muss auf ebenem Untergrund erfolgen. Bei Wandmontagen immer geeignetes Befestigungsmaterial verwenden.
<b>GB US</b>	Furniture must be assembled on a flat surface. For assembly to the wall only use suitable fixing materials.
<b>FR BE NC</b>	Le meuble doit être monté sur une surface plane. Pour le montage mural, utilisez des accessoires de fixation adaptés au type de mur.
<b>NL</b>	De meubels dienen op een vlakke ondergrond te worden gemonteerd. Voor wandmontage moeten geschikte bevestigingsmaterialen worden gebruikt.
<b>IT</b>	Il montage dei mobili deve avvenire su un fondo piano. Per il montaggio si prega di utilizzare solo materiali adatti.
<b>SI</b>	Pohištvo je treba montirati na ravni podlagi. Pri stenski montaži vedno uporabite pritrditveni material.
<b>XS HR BA</b>	Namještaj se mora montirati na ravnoj podlozi. Kod montaže na zid uvijek koristite prikladan materijal za pričvršćivanje.
<b>HU</b>	A bútorszerelését sik felületen kell végezni. Falra szereléshez mindig megfelelő rögzítianyagot kell használni.
<b>BG</b>	Монтажът на мебелите да се извършва на равна основа. При стenen монтаж винаги да се използва подходящ крепежен материал.
<b>CZ SK</b>	Montáž nábytku provádějte na rovném podkladu. Při montáži na stěnu používejte vždy vhodný přípevňovací materiál.
<b>SE</b>	Montering av möbeln måste göras på jämnt underlag. Vid väggmontering ska lämpligt uppfästningsmaterial användas.
<b>RO</b>	Montarea mobilei trebuie să se realizeze pe o pardoseală dreaptă. La montarea la perete utilizați întotdeauna material de fixare adecvat.
<b>ES</b>	El montaje debe efectuarse sobre una superficie uniforme. En el montaje mural emplee siempre el material de fijación adecuado.
<b>D CH AT LI LU</b>	Bitte beachten Sie die Montageanleitung. Halten Sie immer die angegebene Wattzahl ein. Verhindern Sie einen Hitzestau.
<b>GB US</b>	Please observe the assembly instructions. Do not exceed the max. given wattage. Ensure that the heat is not allowed to build up.
<b>FR BE NC</b>	Veillez respecter la notice de montage. Respectez impérativement le nombre des watts maximal. Veillez à éviter toute accumulation de chaleur.
<b>NL</b>	Lees a.u.b. de montagehandleiding door. Houd u beslist aan het max. opgegeven wattage. Zorg ervoor dat geen hittestuwing onstaat.
<b>IT</b>	Attenersi alle istruzioni di montaggio. Rispettarsi rigorosamente il numero di watt max. indicato. Assicurarsi che non si verifichi un accumolo di calore.
<b>SI</b>	Upoštevajte navodila za montažo. Vedno upoštevajte navedeno število vatov. Preprečite zastoj vročine.
<b>XS HR BA</b>	Obratite molimo Vas pozor na uputu za montažu. Uvijek se pridržavajte navedenog broja vati. Izbjegavajte zastoj vrućine.
<b>HU</b>	Vegye figyelembe a szerelési útmutatót. Mindig tartsa be a megadott wattszámot. Akadályozza meg a hirtelődést.
<b>BG</b>	Моля, вземете под внимание ръководството за монтаж. Спазвайте винаги посочените ватове. Избягвайте акумулиране на топлина.
<b>CZ SK</b>	Dodržujte prosím návod k montáži. Vždy dodržujte uvedenou hodnotu výkonu (watt). Zabráníte tak přehřívání.
<b>SE</b>	Följ monteringsanvisningen. Följ alltid angivet wattal. Undvik att hetta uppstår.
<b>RO</b>	Respectați instrucțiunile de montaj. Respectați întotdeauna numărul de wați impus. Evitați acumularea de căldură.
<b>ES</b>	Le rogamos que tenga presente las instrucciones de montaje. Respete siempre el número indicado de vatios. Evite la acumulación de calor.
<b>D CH AT LI LU</b>	Halten Sie die max. zulässigen Belastungswerte der Möbelteile ein. Details siehe Montageanleitung
<b>GB US</b>	Comply with the max. permissible loads. For details, please refer to the assembly instructions
<b>FR BE NC</b>	Respectez les valeurs de charge max. admissibles des parties de meubles. Pour plus de détails, cf. la notice de
<b>NL</b>	Houd de maximaal geoorloofde belastingswaarden van de meubeldelen aan. Voor details verwijzen wij naar de montagehandleiding
<b>IT</b>	Rispettare la portata max. permessa degli elementi del mobile. Per dettagli si vedano le istruzioni di montaggio e si vada
<b>SI</b>	Upoštevajte največjo dovoljeno obremenitev delov pohištva. Podrobnosti najdete v navodilih za montažo in na
<b>XS HR BA</b>	Pridržavajte se maks. Dozvoljenih vrijednosti opterećenja elemenata namještaja. Detalje vidi u uputu za montažu
<b>HU</b>	Tartsa be a bútorelemek max. megengedett terhelési értékeit. A részleteket lásd a szerelési útmutatóban
<b>BG</b>	Спазвайте макс. допустимите стойности на натоварване на мебелите. За подробности виж ръководството за монтаж
<b>CZ SK</b>	Dodržujte max. přípustné hodnoty zatížení nábytkových dílů. Podrobnosti viz návod k montáži
<b>SE</b>	Följ max. tillåten belastning av möbeldelarna. Mer information finns i monteringsanvisningen
<b>RO</b>	Respectați valorile de solicitare max. admise pentru corpurile de mobilier. Pentru detalii consultați instrucțiunile de montaj
<b>ES</b>	Respete los valores máximos de carga admisibles para las piezas de los muebles. Consulte los detalles en las instrucciones
<b>D CH AT LI LU</b>	Zur Möbelreinigung ein mit Wasser befeuchtetes, fusselfreies Baumwolltuch verwenden. Gereinigte Flächen immer trockenreiben!
<b>GB US</b>	To clean the furniture only use a water dampened lint-free cotton cloth. Once cleaned, always wipe the surfaces dry.
<b>FR BE NC</b>	Utilisez un chiffon en coton non pelucheux humidifié avec de l'eau pour nettoyer les meubles. Séchez systématiquement les surfaces nettoyées en les frottant !
<b>NL</b>	Gebruik een met water bevochtigde, pluivrije katoenen doek om de meubels te reinigen. Wrijf gereinigde oppervlakken altijd droog!
<b>IT</b>	Per pulire il mobile utilizzare un panno di cotone inumidito d'acqua e che non perde pelucchi. Asciugare sempre le superfici che si sono pulite!
<b>SI</b>	Za čiščenje pohištva uporabljajte vlažno bombažno krpo, ki ne pušča vlaken. Očiščene površine vedno obrišite do suhega!
<b>XS HR BA</b>	Za čišćenje namještaja koristite sa vodom navlaženu pamučnu krpu koja ne ispušta vlakna. Očiščene površine uvijek obrišite suhom krpom!
<b>HU</b>	Bútortisztításhoz vízzel benedvesített, nem szálazódó pamutkendit használjon. A megtisztított felületeket mindig törölje szárazra!
<b>BG</b>	За почистване на мебелите използвайте навлажнена с вода, неизпускаща влакна памучна кърпа. Почистените повърхности винаги да се изтриват до сухо!
<b>CZ SK</b>	K čištění nábytku používejte bavlněný hadr neuvolňující vlákna, navlhčený ve vodě. Vyčištěné plochy vždy utřete do sucha!
<b>SE</b>	För möbelförrensning används en luddfri bomullsduk fuktad med vatten. Rengjorda ytor ska alltid torkas torra!
<b>RO</b>	Pentru curățarea mobilei utilizați o lavetă din bumbac fără scame umezită cu apă. Suprafețele curățați se șterg întotdeauna până se usucă!
<b>ES</b>	Emplee un paño de algodón humedecido con agua y libre de pelusa para la limpieza de los muebles. ¡Seque siempre las superficies que ha limpiado!