

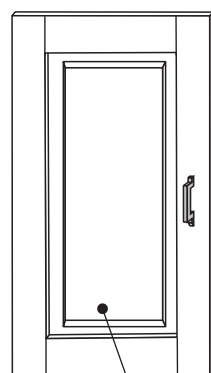

TABULKA S ROZMĚRY A MNOŽSTVÍM BALÍKŮ  
Tabelle mit Maßen/Menge  
und Colli-Nr. der Einzelteile balík

NO č.	Dim.	rozměr/ rozmer	Col.-No	Qty ks
1, 2	1015	378	1	2
3	1922	396	1	1
4	2000	420	1	1
5, 6	919	381	1	2
7	561	100	1	3
8	277	364	1	1
9L, 9R	1015	68	1	2
10	1985	80	1	1
11L, 11R	412	80	1	2
12	1922	78	1	1
13	365	78	1	2
14	1817	80	1	1
15	658	355	2	4
16	931	581	1	1
16L, 16R	931	674	1	2
17	555	190	2	3
18	521	140	2	3
19L, 19R	352	140	2	10
20	532	350	2	3
21L, 21R	276	190	2	2
22	233	140	2	2
23	244	350	2	2
24	832	601	2	2



x2  
24

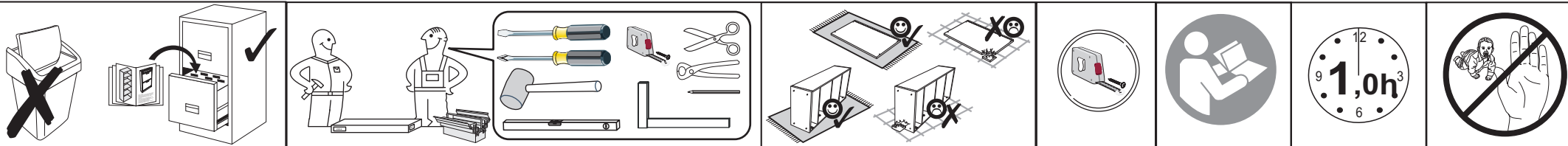
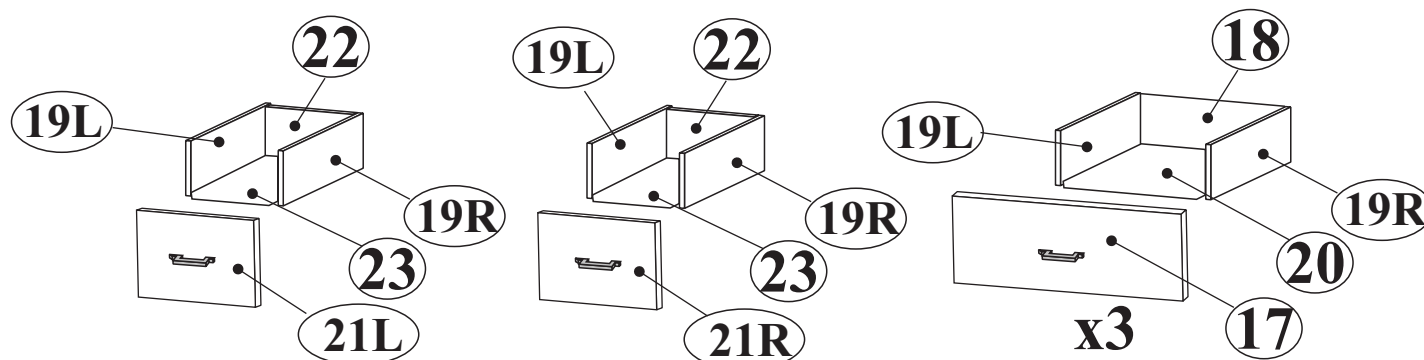
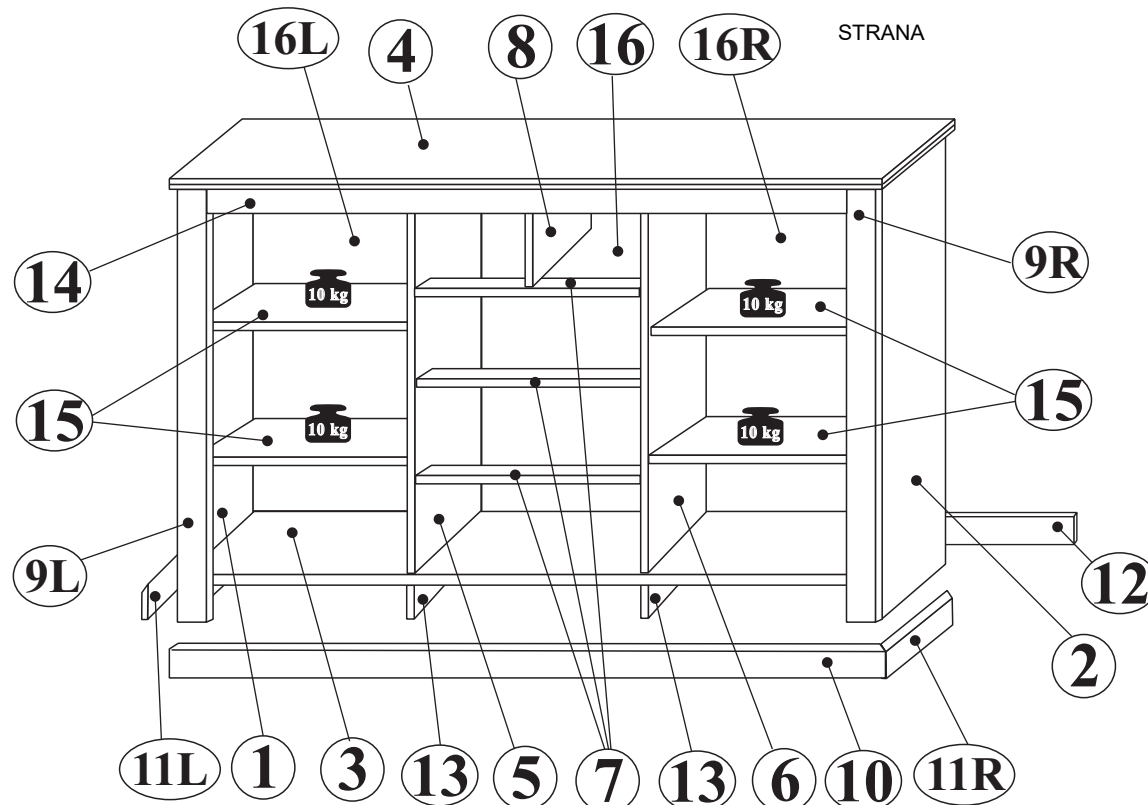

STRANA

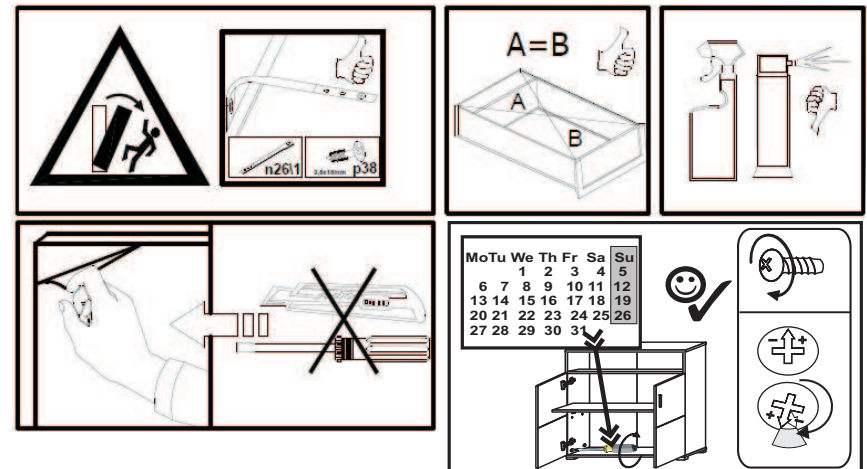
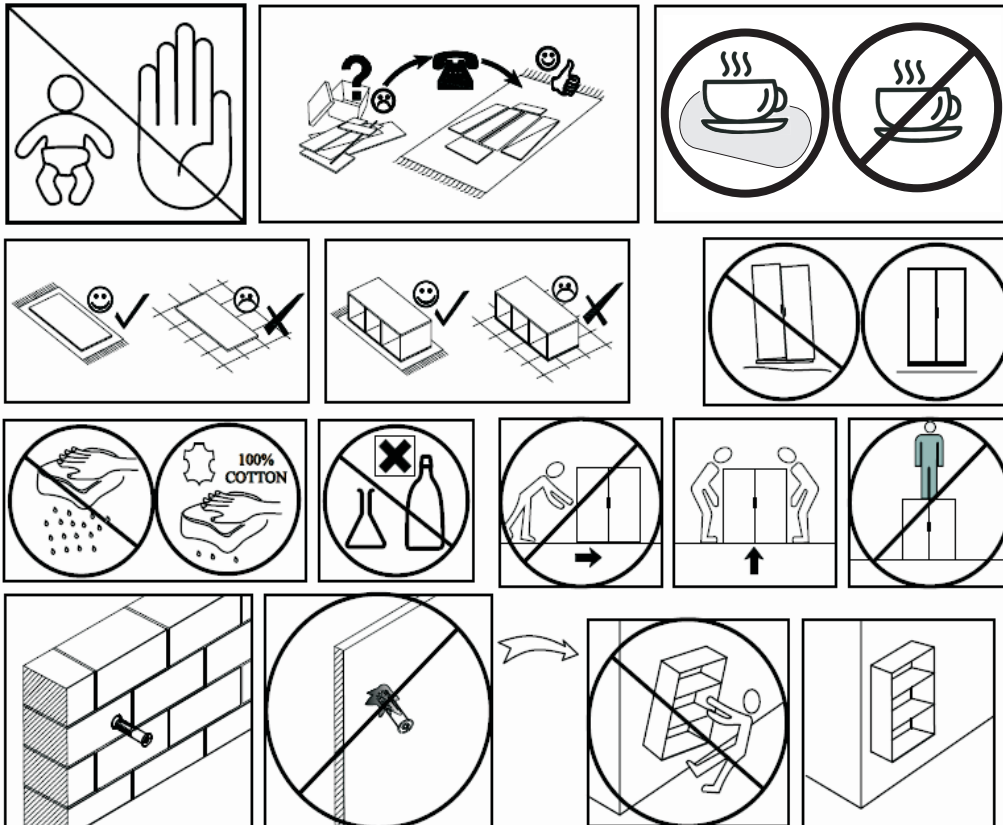
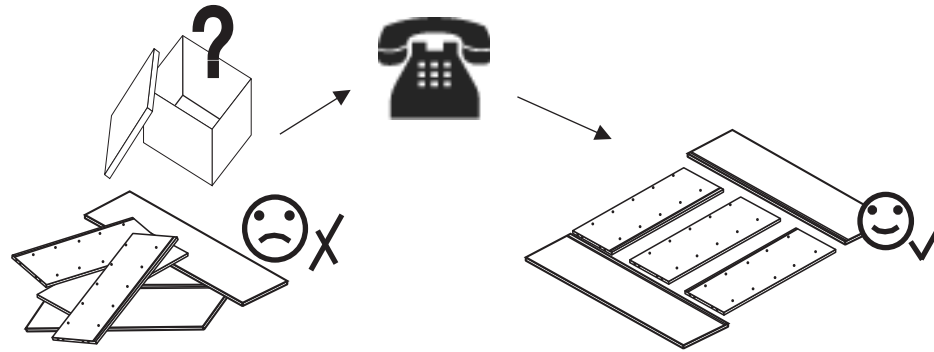

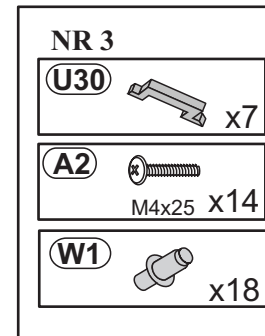
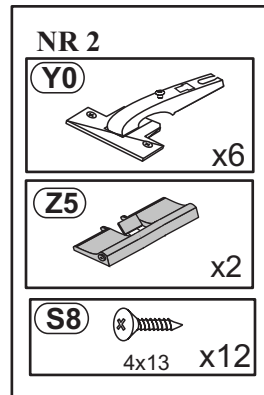
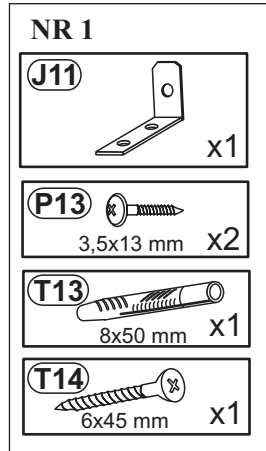

**1**

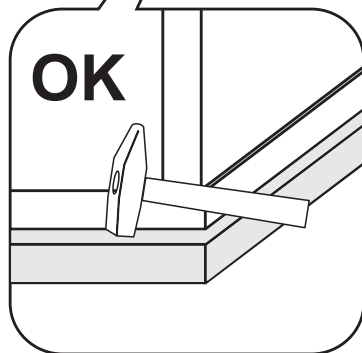
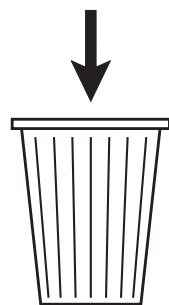
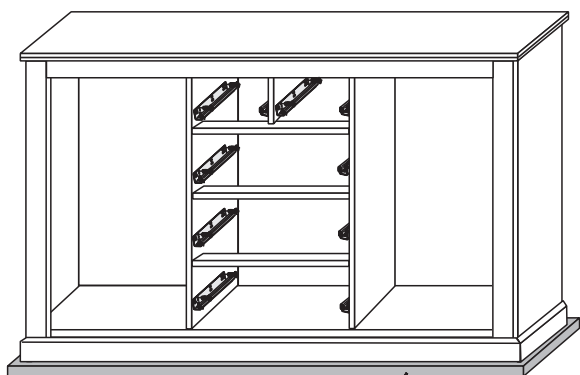

**2**

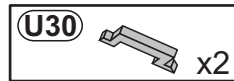
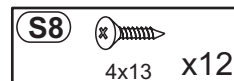
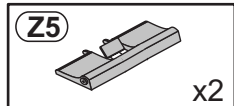
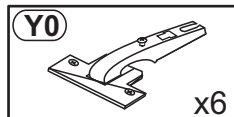
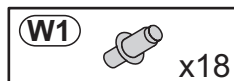

STRANA

